



MEX a kitchen appliance brand that fulfills many people's dreams for a long time with a concept integration of technology and functional innovations which is applicable with urban lifestyle.

MEX creates a new experience to enjoy every single moment in the kitchen with happiness. Begin with the center of kitchen, starting from preparing food at the sink, then stir-frying, boiling and frying at the trendy hob. Don't need to worry about odor smoke from cooking because you have powerful cooker hood. Easy and Fast meal with Microwave oven that you can select various functions to warm up food. After main dish, you need a delicious dessert of bakery from a good multi-function oven, then end of your meal with cleaning station with a dishwashing machine that save your time and money, also safe from various germs for everyone

Extending the happiness of the memorable moments of delicious meals, MEX allows everyone in the family to spend time fully relaxing. Breathe clean air in your home from a well-designed air purifier with functions that truly meet the needs of relaxation. In addition, MEX also provides relief from the tiredness of work time and freshen up in the morning with a uniquely designed water heater.



Explore our products

Oven and Microwave Oven	02
Hob	06
Hood	16
Dishwasher & Dish Dryer	29
Granite Sink	34
Stainless Steel Sink	49
Tap	62
Small Appliance	69
Cordless Vacuum Cleaner	74
Air Purifier	76
Storage Water Heater	79
Water Heater	84
Water Dispenser	93
Household Water Filter	95
Drinking Water Purifier	103



01

Oven and Microwave Oven

Things that invite creativity at home



Built-in Microwave Oven

BUILT-IN MICROWAVE OVEN

CM925BX BUILT-IN MICROWAVE OVEN

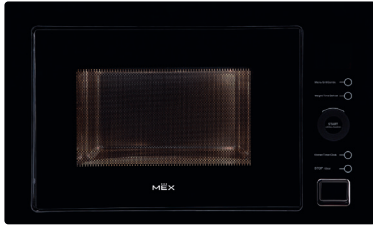

More details and review on website

- Material : Black glass / Stainless steel
- Height 40 cm. Capacity 25 Litre
- Microwave power 900 W./Grill power1,000 W
- Microwave and Grill combination function
- Defrost by time / weight
- 8 menus Auto cooking programmes
- Digital Display
- Touch Control
- Max Cooking Timer 95 Minute
- Quick program 30 Sec
- Safety Child Lock
- 31.5 cm. turntable plate diameter
- Grill Rack



MM625BX BUILT-IN MICROWAVE OVEN



More details and review on website

- Material : Stainless steel
- Height 40 cm. Capacity 25 Litres
- Microwave power 900 W./ Grill power1,000 W
- Microwave and Grill combination function
- Defrost by time / weight
- 8 menus Auto cooking programme
- Digital Display
- Knob control and Electronic push button
- Max Cooking Timer 95 Minute
- Quick program 30 Sec
- Safety Child Lock
- 31.5 cm. turntable plate diameter
- Grill Rack



MM625S BUILT-IN MICROWAVE OVEN



- Material : Stainless steel
- Height 40 cm. Capacity 25 Litres
- Microwave power 900 W./ Grill power1,000 W
- Microwave and Grill combination function
- Defrost by time / weight
- 8 menus Auto cooking programmes
- Digital Display
- Max Cooking Timer 95 Minute
- Quick program 30 Sec
- Safety Child Lock
- 31.5 cm. turntable plate diameter
- Grill Rack



Table Top Microwave Oven & Grill

Free Stand Microwave Oven with Grill Combination



8 AUTO MENU



▶ 30 SEC
30-SECOND QUICK START



M120E

- Size 44 x 25.8 x 33 cm. Capacity 20 Litres
- Microwave power 700 W Grill power 1,000 W
- Microwave and Grill combination function
- Defrost by time / weight
- 8 menus Auto cooking programmes
- Digital Display
- Knob and Button control
- Max Cooking Timer 95 Minute
- Quick program 30 Sec
- Lock control panel function.
- 24.5 cm. turntable plate diameter
- Grill Rack



More details and review on website





STEAMBASE OVEN

Steam Assisted Cooking to keep tenderness moisture in food.

Multi-Function Oven

MULTI FUCTIONAL BUILT-IN OVEN



3D Cooking + Steam Base
 Make cooking more easier with special meal like roast chicken and pork ribs which can keep tenderness and moisture of food.

VRM9652B SteamBase

MULTI FUCTIONAL BUILT-IN OVEN

- Material : External Black glass / Enamelled Inside for easily clean
- Size 60 cm. Capacity 65 Litres
- 9 Cooking programes with 3D Cooking
- Cooking temperature 50-260 °C
- White color Digital Display
- Program set up by knob control
- Automatic Alarm
- Automatic Cooking
- Automatic Delay start timer
- Steam Base Technology for Cooking with steam assisted to keep tenderness and

- moisture in food.
- Steam Cleaning
- Tempered glass Door with 2 glasses
 - > External Black glass
 - > Full inner door glass with Low-e glass to support energy saving and easily remove the door glass
- Ventilated Cool Door to reduce heat on the front side efficiently
- 5 levels of detachable rack side support and Accessories : Big Tray 1 pc, Small Tray 1 pc, Rack 1 pcs
- Energy efficiency class Class A
- Made in Europe

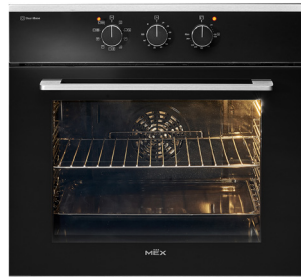

3D Cooking + Steam Base
 Make cooking more easier with special meal like roast chicken and pork ribs which can keep tenderness and moisture of food.

VRM9651B SteamBase

MULTI FUCTIONAL BUILT-IN OVEN

- Material : External Black glass / Enamelled Inside for easily clean
- Size 60 cm. Capacity 65 Litres
- 9 Cooking programes with 3D Cooking
- Cooking temperature 50-260 °C
- Program set up by knob control
- Steam Base Technology for Cooking with steam assisted to keep tenderness and moisture in food.

- Steam Cleaning
- Tempered glass Door with 2 glasses
 - > External Black glass
 - > Full inner door glass with Low-e glass to support energy saving and easily remove the door glass
- Ventilated Cool Door to reduce heat on the front side efficiently
- 5 levels of detachable rack side support and Accessories : Big Tray 1 pc, Small Tray 1 pc, Rack 1 pcs
- Energy efficiency class Class A
- Made in Europe



Free Standing Cooker

Free Stand Cooker

CMG469X

Free Stand Cooker stainless steel 60 cm.

- Cooker body has wall mounted leg for safety
- Energy Efficiency Class : A
- Made in Europe



Gas Hob

- 4 SABAF gas burners included
- Front left : Tripple flame burner 3.8 kW.
- Front right : Power 1,000 W
- Rear left : Power 1,750 W
- Rear right : Power 1,750 W
- Metal pan support
- A metal trivet for Wok support
- Premium Glass cover with rubber bumpers
- Electric auto-ignition
- Safety Valve

MULTI FUNCTIONAL OVEN

- Capacity 65 Litres
- 9 Cooking programmes
- Cooking temperature 260° C
- Easily Knob control to set up Program and Temperature
- White Digital Display
- Electronic Cooking Timer
 - > Automatic Alarm
 - > Automatic Cooking
 - > Automatic Delay start timer
- Steam Cleaning
- Tempered glass Door with 2 glasses
 - > Full inner door glass with Low-e glass to support energy saving and easily remove the door glass
- Oven cavity Light 1 unit (1 x 25 Watt.)
- 5 levels of detachable rack side support
- Accessories : Enamelled Tray 1 pc Rack 2 pcs



Symbol guideline:

Energy Class: A	Defrost	bottom & top heat with Fan assisted	Light in Oven Cavity	Stream Cleaning with Bottom heating
Cool front door	Grill	Bottom & Top heat with Fan assisted	Defrost and light	Top Heating, Hot Air, Fan Assisted & Oven Light
Touch Control	Grill with Fan	Bottom heat with Hot Air Fan assisted	Bottom heat with light	Bottom Heating, Hot Air, Fan Assisted & Oven Light
Hot Air & Fan	High Grill with Fan	Bottom heat with Fan assist and steam clean	Bottom & Top heat with light	Bottom - Top Heating, Fan Assisted & Oven Light
Quick start 30 Sec	Bottom heating	Hot Air Fan with Microwave	Grill with Light	Bottom - Top Grill, Fan Assisted & Oven Light
Safety Child Lock	Top Heating	Grill with Fan and Microwave	Bottom & Top Grill with Light	Steam Base : Cooking with Steam assist
Auto Cooking Timer	Bottom & Top Heating	Grill and Microwave	Grill and Fan with light	
Microwave	Top heat, Fan assisted	Bottom heat with Hot Air Fan and Microwave	Hot Air Fan with light	

02

| Hob

Upgrading the look
and feel of your kitchen



Induction hob

Rapid Heat Generating, Safety and Energy Saving with Induction Hob

"The Electromagnetic Cooker" or "Induction Cooker" has been used throughout for cooking because it assures the customer high safety. This is because an electromagnetic field is generated by an electronic circuit, which will not cause the heat around the furnace glass, instead, the heat will be generated only on the point of the bottom container that has been conducted, as a result, it doesn't heat up the furnace glass. Therefore, it makes a comfortable and safe consumption for consumers.



HIM364

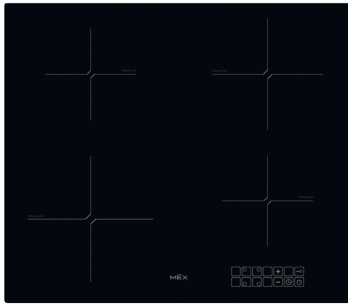

- High quality Ceramic Glass base
- 4 Cooking Zones
- Front left : 21.4 cm. Power 2,000 W
- Front right : 15.5 cm. Power 1,500 W
- Rear left : 15.5 cm. Power 1,500 W
- Rear right : 18.9 cm. Power 2,000 W
- 9 levels of power cooking
- Individual timer for all 4 cooking zones (1-99 min).
- "A" Function for Automatic heat up control
- "U" Function for warming or simmering
- Residue heat indicator
- Overflow Protection Auto switch off when water pour on cooking zones
- Automatic pan detection.
- Max Nominal Power 7,000W



More details and review on website



HIM432

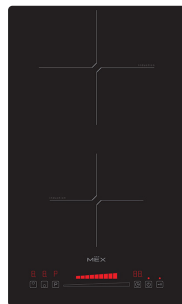

- High quality Ceramic Glass base
- 2 Cooking Zones
- Front : power 1,500 W
Power Booster 1,800 W
- Rear : power 2,000 W
Power Booster 2,300 W
- Slide Control 9 levels of power cooking
- Individual timer for all 2 cooking each zones (1-99 min)
- "A" Function for Automatic heat up control
- "U" Function for warming or simmering
- Residue heat indicator
- Overflow Protection Auto switch off when water pour on cooking zones
- Automatic pan detection. Child safety lock function
- Max Nominal Power 3,500 W



Symbol guideline:



Touch Control



Safety Valve Automatic Gas cut



Speed up cooking temperature



Automatic electronic ignition with Battery D 1.5 V



Slide Control



Auto cooking Timer



Simmering Program



Automatic electronic ignition with Battery C 1.5 V



Pause



Safety Child Lock



Automatic electronic ignition



Induction Hob with Ceramic Glass base

Bridge Zone

Maximum space for more cooking flexibility



Expand the cooking zone with the Bridge Function that sharing the area of two burners to be combined as a large heating zone, in order to be applicable with larger containers.



FASTER HEATING,
TIME-SAVING
COOKING

Speed up heating level with
Booster Function



SIMPLY PAUSE
WHILE COOKING

Temporary pause max
10 minutes



TIMER, MAKE LIFE
EASIER

Automatic Turn on/off set up
in advance 120 minutes



HI-CLASS, HI QUALITY
CERAMIC GLASS

Premium quality glass material
from Eurokera Glass made in
Europe



TOUCH & SLIDE
FOR SELECTION

Punctual temperature level
selection



SAFE AND SECURE
YOUR LOVE ONES

Insure Family safety with
Child Locks function

Bridge Zone Induction Hob

BUILT-IN INDUCTION BRIDGE ZONE HOB

VFL6564



MADE IN ITALY



- 60 cm. built in induction hob with front-bevelled.
- EUROKERA ceramic glass
- 4 cooking zones E.G.O.
 - Front left : 190 x 210 MM.
 - Power 2,100 W
 - Power Booster 3,000 W
 - Rear left: 190x210 MM.
 - Power 2,100 W
 - Power Booster 3,000 W
 - Front right : 190x210 MM.
 - Power 2,100 W
 - Power Booster 3,000 W
 - Rear right : 190x210 MM.
 - Power 2,100 W
 - Power Booster 3,000 W
- Touch Control
- 9 power levels heat setting with Slide Control
- Cooking Timer : 1-120 minutes• Individual timer for all 4 cooking zones (1-120 min)
- The Bridge function allows you to combine two cooking zones to a single large zone, suitable for large cookwares
- A function : Automatic heat up function
- U function : Keep warm function
- Pause function : Left a hob for 10 minutes and reactivated when returned
- Recall function : Allows to recall the last settings-selected in 6 seconds after accidentally turned off
- Child safety lock• Pot detection• Residue heat indicator
- Nominal Power7,400 W 220-240V., 50-60 Hz. Made in Italy

VFL6563



MADE IN ITALY



- 60 cm. built in induction hob with front-bevelled.
- EUROKERA ceramic glass
- 3 cooking zones E.G.O. :
 - Front left : 190x210 MM.
 - Power 2,100 W
 - Power Booster 3,000 W
 - Rear left : 190x210 MM.
 - Power 2,100 W
 - Power Booster 3,000 W
 - Front right : 250 MM.
 - Power 2,300 W
 - Power Booster 3,000 W
- Touch Control
- 9 power levels heat setting with Slide Control
- Cooking Timer : 1-120 minutes
- Individual timer for all 3 cooking zones (1-120 min)
- The Bridge function allows you to combine two cooking zones to a single large zone,
- A function : Automatic heat up function
- U function : Keep warm function
- Pause function : Left a hob for 10 minutes and reactivated when returned
- Recall function : Allows to recall the last settings selected in 6 seconds after accidentally turned off
- Child safety lock
- Residue heat indicator
- Nominal Power 6,700 W 220-240V. , 50-60 Hz.
- Made in Italy

VFL6532

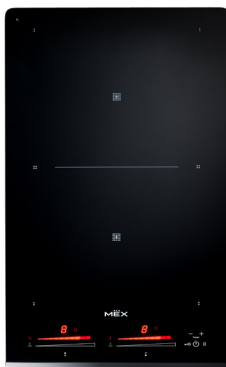

MADE IN ITALY



- 30 cm. built in induction hob with Front-bevelled
- EUROKERA ceramic glass
- 2 cooking zones E.G.O.
 - Front : 190x210 MM.
 - Power 2,100 W
 - Power Booster 3,000 W
 - Rear: 190x210 MM.
 - Power 2,100 W
 - Power Booster 3,000 W
- Touch Control
- 9 power levels heat setting with Slide Control
- Cooking Timer : 1-120 minutes
- Individual timer for all 2 cooking zones (1-120 min)
- The Bridge function allows you to combine two Cooking zones to a single large zone,
- A function : Automatic heat up function
- U function : Keep warm function
- Pause function : Left a hob for 10 minutes and
- Recall function : Allows to recall the last settings selected in 6 seconds after accidentally turned off
- Child safety lock
- Pot detection
- Residue heat indicator
- Nominal Power 3,700 W. 220-240V., 50-60 Hz.,
- Made in Italy



VRH Series

To enlarge more cooking space for various sizes of pot/pan

New Ceramic Hob with Premium Quality Base Glass from EuroKera comes together with E.G.O burner to enhance the efficiency of cooking performance.

With more functions that benefit the user, the single burner can be fit to various sizes of container from small-medium to large one and Power Booster function that speeds up heat to reach maximum in short time.

VRH6264

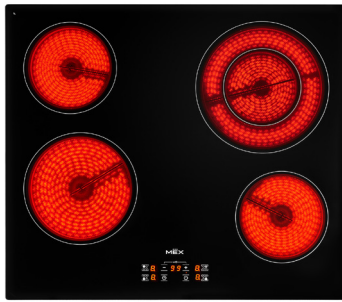

MADE IN ITALY

- Base Ceramic Glass 60 cm.
- Premium glass from EuroKera
- 4 cooking zones E.G.O. Burner:
 - Front Left : Hi-Light Burner
ø 180 mm. Power 1,800W
 - Rear Left : Hi-Light Burner
ø 140 mm. Power 1,200W
 - Front Right Hi-Light Burner
ø 140 mm. Power 1,200 W
 - Rear Right : Hi-Light Burner Double Rings
ø 120/210 mm. Power 750/2,200 W

- Touch Control
- 9 levels of power cook with Power booster
- Individual timer for all 4 cooking zones 1-99 min
- Residue heat indicator
- Child safety lock
- Made in Italy
- Nominal Power 6,400W



VRH6263



MADE IN ITALY

- Base Ceramic Glass 60 cm.
- Premium glass from EuroKera
- 3 cooking zones E.G.O. Burner:
 - Front Left : Hi-Light Burner
ø 180 mm. Power 1,800W
 - Rear Left : Hi-Light Burner
ø 140 mm. Power 1,200W
 - Right : Main Hi-Light Burner Triple Rings
ø 140/210/270 mm. Power 1050/1950/2700 W

- Touch Control
- 9 levels of power cook with Power booster
- Individual timer for all 3 cooking zones 1-99 min
- Residue heat indicator
- Child safety lock
- Made in Italy
- Nominal Power 5,700W



VRH6232

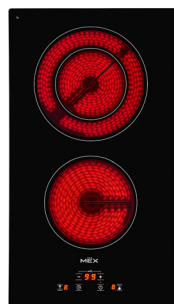

MADE IN ITALY

- Base Ceramic Glass 30 cm.
- Premium glass from EuroKera
- 2 cooking zones E.G.O. Burner:
 - Front: Hi-Light Burner
ø 140 mm. Power 1,200W
 - Rear : Hi-Light Burner Double Rings
ø 120/180mm. Power 700/1700 W
- Touch Control

- 9 levels of power cook with Power booster
- Individual timer for all 2 cooking zones 1-99 min
- Residue heat indicator
- Child safety lock
- Made in Italy
- Nominal Power 3,700 W



Ceramic Hob

Built-In CERAMIC Hob with Ceramic Glass Base

Better way to be HAPPY WITH COOKING

MEX Original patent design to widen more space between cooking zones, so that a user is able to use 2 large kitchenware to cook 2 zones at the same time with design of Vertical and Horizon Hob

*MEX ORIGINAL PATENT



HVH632N



LEFT: 18.6 cm. Power 1,800 W

RIGHT: 15.5 cm. Power 1,200 W

- 9 Levels of power cooking
- Individual timer for all 2 zones 99 min
- Residue heat indicator
- Nominal Power 3,000 W
- **MEX ORIGINAL PATENT DESIGN**

- Horizontal Hob widen space between cooking zone 10 cm.
- High quality ceramic base
- 2 cooking zones



HVN632



- NEW DESIGN widen space between zones 8 cm. for conveniently use
- High quality ceramic base
- 2 cooking zones
FRONT : 15 cm. Power 1,200 W
REAR : 18 cm. Power 1,800 W
- 9 levels of power cooking
- Individual timer for all 2 cooking zones (99 min)
- Residue heat indicator
- Nominal Power 3,000 w
- **MEX ORIGINAL PATENT DESIGN**



HVN264



- Base Ceramic Glass.
- 4 cooking zones
Front left : 20 cm. Power 1,800 W
Front right : 18 cm. Power 1,500 W
Rear left : 21.5 cm. Power 2,000 W
Rear right : 16.5 cm. Power 1,200 W
- 9 levels of power cooking
- Individual timer for all 4 cooking zones (1-99 min).
- A function : Automatic heat up function
- U function : Keep warm function
- Residue heat indicator
- Child safety lock
- Nominal Power 6,500 W



To meet your satisfaction by the special flame designed for variety of cooking menus.

LOTUS FLAME

V7812MHR



HIGH POWER

Newly designed burners create long flames bowing to the center, so its appearance looks like The Lotus which efficiently delivers strong heating flame to the container.

SIMMER FLAME

The Burners offer low heat cooking flame, it is designed fixing small flame under large flame to generate heating thoroughly



STRONG FIBER MESH

MEX strong fiber mesh tempered glass offers security for the user. The fiber mesh reinforces the tempered glass to prevent risks from thermal shock on the glass.

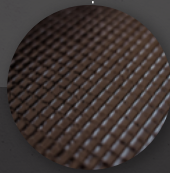

HEAT REFLECTOR

The heat reflector enhances the area of completed combustion, and heating flame reaches to the container better 2-3%

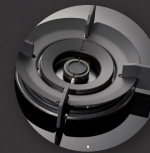

The center burner designed like honeycomb



Direct Flame "Bon Fire"

raises the heating flame up to the container directly. It minimizes the heat loss of inner ring which designed like a honeycomb



"Brass Burner Black Coating"

Classic aesthetic and extend long service life, it conducts heat rapidly without the energy waste.

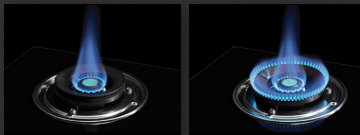

Bonfire

V2772MHR

This is suitable for every concept of Modern Kitchen, enjoy with cook various recipe and international menus.

Glass Base Gas Hob Built in Gas Hob Tempered Glass

V7863TR



- Built in Gas Hob
- Strong Fiber Mesh Tempered Glass base all 4 sides-bevelled edge
- 2 Brass burners
 - Left : Tripple Flame power 6,400 w
 - Right : Tripple Flame power 6,400 w
- Innovative Triple Rings which can be offered simmering flame for all rings.
- 2 small trivets for small pot
- Special designed Black Control Knob by MEX
- Electric auto-ignition, battery D 2 x 1.5 Volt
- Safety valve



- Metal pan supports

V7828MHR



- Built in Gas Hob with heat reflector
- Strong Fiber Mesh Tempered Glass base all 4 sides-bevelled
- 2 Brass burners
 - Left : Double Flame power 4,500 w
 - Right : Double Flame power 4,500 w
- Metal Heat Reflectors with Black color coating to enhance cooking power
- Metal pan supports
- 2 small trivets for small pot
- Special designed Black Control Knob by MEX
- Electric auto-ignition, battery D 2 x 1.5 Volt
- Safety valve



V7812MHR



- Built in Gas Hob with heat reflector
- Strong Fiber Mesh Tempered Glass base 4 sides-bevelled
- 2 burners with new innovative "Lotus Flame"
 - Left : Double Flame power 4,800 w
 - Right : Double Flame power 4,800 w
- Metal Heat Reflectors with Black color coating to enhance cooking power.
- Metal pan supports with Black color coating
- Electric auto-ignition, battery D 1.5 Volt
- Safety valve.



V2772MHR



- Built in Gas Hob with heat reflector
- Strong Fiber Mesh Tempered Glass base
- 2 Brass innovative "BONFIRE"
 - Left : Double Flame power 5,000w
 - Right : Double Flame power 5,000w
- Metal Heat Reflectors with Black color coating to enhance cooking power.
- Metal pan supports with Black color coating
- Electric auto-ignition, battery D 1.5 Volt
- Safety valve.



V3772MHR



- Built in Gas Hob with heat reflector
- Strong Fiber Mesh Tempered Glass base
- 2 Brass burners
 - Left : Double Flame power 5,000w
 - Right : Double Flame power 5,000w
- Metal Heat Reflectors with Black color coating to enhance cooking power.
- Metal pan supports with Black color coating.
- Electric auto-ignition, battery D 1.5 Volt
- Safety valve.



Glass Base Gas Hob

Built in Gas Hob Tempered Glass

V7835C



- Built in Gas Hob
 - Strong Fiber Mesh Tempered Glass base 4 sides-bevelled
 - 3 Brass burners
 - Electric auto-ignition, battery D 1.5 Volt
 - Safety Valve
 - Metal pan supports
- Left : Double Flame power 5,000 w
 Right : Double Flame power 5,000 w
 Middle : Double Flame power 1,350 w



V7825C



- Built in Gas Hob
 - Strong Fiber Mesh Tempered Glass base 4 sides-bevelled
 - 2 Brass burners
 - Electric auto-ignition, battery D 1.5 Volt
 - Safety Valve
 - Metal pan supports
- Left : Double Flame power 5,000 w
 Right : Double Flame power 5,000 w



V4731M

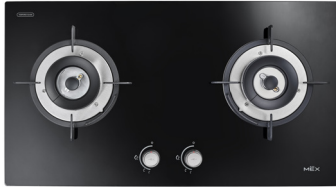

- Built in Gas Hob
 - Strong Fiber Mesh Tempered Glass base
 - 2 Brass burners
 - Special designed Black Control Knob by MEX
 - Electric auto-ignition, battery D 1.5 Volt
 - Safety Valve
 - Included 2 gas rubber For right and Left
 - Small trivets for small pot
- Left : Double Flame power 4,800 w
 Right : Double Flame power 4,800 w



V712M

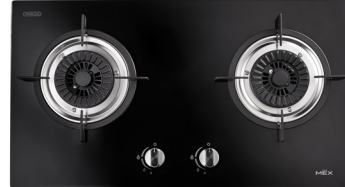

- Built in Gas Hob
 - Strong Fiber Mesh Tempered Glass base
 - 2 Brass burners Black Coating
 - Special designed Black Control Knob by MEX
 - Electric auto-ignition, battery D 1.5 Volt
 - Safety Valve System
 - Small trivets for small pot
 - New Innovative "TOP SPIN POWER" Strong spinning Flame direct to pan/pot
 - Metal pan supports
- Left : Double Flame power 4,500 w
 Right : Double Flame power 4,500 w



Hob Accessories

Gas Hob Accessories

LPG Low pressure regulator is made from high-quality material for durability. Pressure regulator with gauge for constant 35 millibar outlet pressure suit for built-in gas hob installation to support gas heating control and prevent gas waste

Tips : Recommend Gas Hob for Home user to use Pressure regulator with gauge for constant 35 millibar outlet pressure for safety sake.



SPR37S GH

- Low Pressure regulator with gauge and safe valve
- PVC Hose 2 metres long
 - Hose Belt 2 pcs



SPR37S FH

- Low Pressure regulator with safe valve
- PVC Hose 2 metres long
 - Hose Belt 2 pcs

SPR37S

- Low Pressure regulator with safe valve



A093 SCRAPER

- Cleaning Scraper for Ceramic base



A117

- Stainless steel blade for scraper 1 box 10 pcs

Stainless Steel Gas Hob

Built in Gas Hob Stainless Steel base

SB362X/4.2



- Stainless steel base
- 3 Gas Hob / 1 rapid hot plate
- Front left (Gas hob)
: Ultra Triple Flame power 4,200 w
- Front right (Gas hob) : power 1,000
- Rear right (Gas hob) power 1,750 w
- Rear left (Electronic)
: rapid hot plate size 14.5 cm.
power 1,500 w
- Automatic electronic ignition
- Enamelled pan stands
- Wok support
- Made in Italy



BOX6

Stainless steel



- Stainless steel base
- 4 Gas Hob
- Front left Ultra rapid burner 4,200 w
- Front right : power 1,000 w
- Rear left : power 1,750 w
- Rear right : power 3,000

BOX6B

Black Stainless steel



- Automatic electronic ignition
- Enamelled pan stands
- Wok support
- Made in Italy



MX7825C



- Stainless steel base
- 2 Gas Hob brass burners Ultra burner
- Left : Double Flame power 5,000 w
- Right : Double Flame power 5,000 w
- Automatic electronic ignition: - battery D 1.5 Volt
- Safety Valve
- Cast iron pan stands.



MX472M



- Built-in Gas Hob size 72 cm.
- High quality stainless steel base
- 2 Gas Hob brass burners
- Left : Double Flame power 4,800 w
- Right : Double Flame power 4,800 w
- Metal pan supports
- A small trivet for small pot.
- Special designed MEX control knob
- Electric auto-ignition, battery D 1.5 Volt
- Safety Valve
- Included 2 gas rubber hose holders



MX712M

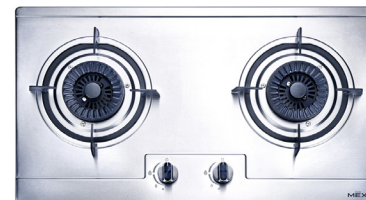

- New Innovative TOP SPIN POWER™ Strong spinning Flame direct to pan/pot
- Stainless steel base
- 2 burners Stainless Steel black coating
- Left : Double Flame power 4,500 w
- Right : Double Flame power 4,500 w
- Electric auto-ignition, battery D 1.5 Volt
- Safety Valve
- Matt Black Enamel pan stands



Free Stand Gas Cooker

Free Stand Gas Cooker

PSG561X



- Free Stand Gas Cooker Stainless Steel
- Super Big Burner \varnothing 16.0cm.
Directional Flame 5,000 W
- Knob Control easily use
- Inner / Outer ring burner control knob separately or use them at the same time
- Flame Barrier with metal pan support.
- Provide space 7 holes on the side to fit for Seasoning Bottles
- 2 shelves of drawer for draining grease and food scrap which is easy to clean
- Extra trivet for small pot

Table Top

Table Top Gas Cooker

PC6892IG



- Tempered glass Table Top Gas Cooker
- 2 burners : 1 Infrared burner / 1 gas burner
Left : Infrared burner double flame Power 3,000W
Right : Brass Burner with black coating double flame Power 3,800W
- Extra trivet for small pot
- Removeable honey comb furnace for Infrared.
- Dimension : 72.0 x 37.5 x 8.0 cm.

PC6792I



- Tempered glass Table Top Gas Cooker
- 2 Infrared Burners
Left : ø 16 cm. Double Flame Power 3,000 W.
Right : ø 16 cm. Double Flame Power 3,000 W.
- Extra trivet for small pot
- Removeable honey comb furnace for Infrared.
- Dimension : 72.0 x 37.5 x 8.0 cm.

PC727CB



- Tempered Black glass Table Top Gas Cooker with Stainless Steel panel coating black
- 2 Brass Burners with black coating
Left : Double Flame Power 3,800 W.
Right : Double Flame Power 3,800 W.
- Ring Alarm Timer max 55 min
- Matt finished metal pan support
- Dimesion : 71.0 x 42.0 x 12.8 cm.

PC577I3



- Zebra Tempered glass Table Top Gas Cooker
- 2 Brass Burners
Left : Directional Flame Burner Double Flame Power 2,800 W
Right : Directional Flame Burner Double Flame Power 2,800 W
- Piezo Automatic Ignition
- Dimension : 72.0 x 41.0 x 7.0 cm.

PCM1608



- Tempered Black glass Table Top Gas Cooker
- 2 Titanium Burners
Right : Titanium Burners Power 4,400 W
Left : Titanium Burners Power 4,400 W
- Body Stainless Steel
- 2 metal pans support
- Extra trivet for small pot 1 pc
- Piezo Automatic Ignition
- Dimension : 72.2 x 37.2 x 6.0 cm.

PCM1605



- Stainless Steel Table Top Gas Cooker
- 2 Titanium Burners
Right : Titanium Burners Power 4,400 W
Left : Titanium Burners Power 4,400 W
- 2 metal pans support
- Extra trivet for small pot 1 pc
- Piezo Automatic Ignition
- Dimension : 68.2 x 38.0 x 10.0 cm.

Table Top

Table Top Gas Cooker

PC717CB



- Tempered Black glass Table Top Gas Cooker with Stainless Steel panel coating black
- 1 Brass Burners with black coating
- Double Flame Power 3,400 W
- Matt finished metal pan support
- Piezo Automatic Ignition
- Dimension : 31.0 x 41.0 x 16.5 cm.

PC628I



- Tempered glass Table Top Gas Cooker
- 1 Infrared Burners \varnothing 16 cm. Double Flame
- Power 3,000 W.
- Matt finished metal pan support
- Extra trivet for small pot
- Removeable honey comb furnace for Infrared.
- Dimension : 31.0 x 43.2 x 11.3 cm.

PC528I

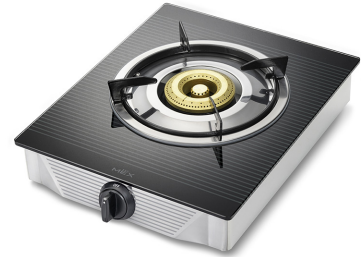

- Tempered glass Table Top Gas Cooker
- 1 Brass Burners
- DoubleFlame Power 2,800 W
- Enamelled pan support
- Piezo Automatic Ignition
- Dimension 31.0 x 43.2 x 11.3 cm.

Induction Cooker Table Top Induction Cooker

PIC11S



FREE!



- Induction Cooker 1 zone
- Diameter \varnothing 19.6 cm.
- Knob controller 9 power levels
- Maximums 240 minutes to set timer with light indicator display
- Child lock safety within 1 minutes
- Dimension 20.7 x 32.5 x 5.5 cm.
- Power 2,000 W

MIN202C



- High quality Tempered Glass base with cream color
- 2 matte silver color brass burners
- Left : Double ring burner 3,400 W
- Right : Double ring burner 3,400 W
- Matte silver metal pan supports
- 55 minutes reminder cooking timer
- Matte silver Piezo automatic ignition
- Dimension : 72.0 x 38.5 x 7.0 cm

Cookware

MP10128



- Aluminium Grill pan with 3 non-stick layers
- Square Design Diameter 28 cm.
- PFOA&PFOS Free
- Non-Stick, easy to clean
- Stylish Wooden handle

CSA247CR



- Aluminium Casserol with Glass Lid/ Cream
- Diameter 24cm.
- Container 3.4 Liters
- PFOA&PFOS Free
- Heat Resistance Silicon knob and handles
- Attache Induction plate underneath
- 6-Non-Stick Layer High Quality Coating
- Glass lid with extra steam holes
- Non-Stick, easy to clean



03

| Hood

Sophisticated in design,
very efficient in use

Cooker Hood

COOKER HOOD METRIX

METRIX

PLANA BL

- Hood with Down Draft installation
- Elegant design with new innovative
- Adjustable Up-Down Hood panel
- 1 high performance motor : 275 W
- Net extraction rate 710 m3/h. (IEC: EN61591)
- Touch Control on Perimeter with Tempered black glass
- 4 speeds,with intensive speed 10 minutes
- Low noise level just 70 dB(A).when max power (IEC: EN60704-3)
- Automatic delayed swith off 30 minutes
- Room Comfort Mode for slowly ventilate air inside the kitchen 24 hour timer.
- Filter Cleaning alarm
- LED Light
- Installed Counter with dept at least 80 cm
- Nominal power 290 W
- Made in Italy



ISOLA RO



- Stainless Steel Island Hood with Diameter ø 37 cm.
- Electronic Button Controller
- Motor 250 W
- Gross extraction 1,050 m3/h.
- Net extraction rate 812 m3/h.
- 3 speeds with intensive 1 speed
- Enhance Exhausting system with Perimeter Ventilation.
- 2 LED Lamps
- Can use Dual mode: Re-circulated mode & External mode
- Nominal power 250 W
- Made in Italy



DOPPIO BL



- Decorative Wall hood Stainless steel
- Touch Control on Perimeter with safty black glass
- Motor 250 w
- Net extraction rate 690 m3/h. (IEC: EN61591)
- 4 speeds,with intensive speed 10 minutes
- Low noise level just 70 dB(A). when max power (IEC: EN60704-3)
- Automatic delayed swith off 30 minutes
- 2 halogen lamps
- Nominal power 290 W
- Made in Italy



Symbol guideline:



Touch Control



Automatic Slide Control



Filter Cleaning alarm



Can use extraction mode only



Electronic Button Control



Adjustable Up-Down Hood panel from top furniture



Air Ventilation system 24hrs



Recirculation mode. applicable



Manual Press Button control



Automatic switch off



Triphase Motor



Remote Control



Silent Mode



BAFFLE FILTER CHIMNEY HOOD

HONEY COMB
BAFFLE FILTER 3 Levels

Special Sloped Filter with Oil tray

MEX designs BAFFLE FILTER by creating tripple filler and add thin filler at the middle to increase capability of grease and oil extraction and conveniently clean.



Baffle Filter Chimney Hood

CHIMNEY HOOD WITH BAFFLE FILTER

K637BFX90



- Modern T-Shape Chimney Hood stainless steel
- Front Panel with Black Glass
- 1 Motor : 380 W, Aluminium alloy housing, heat resistant, rust proof
- Gross extraction 1,188 m3/h.
| Net extraction rate 950 m3/h
- Honey Comb Stainless Steel Baffle tripple filter
- Removable Oil tray easily clean
- 4 Speeds
- Power off delay timer 3 and 7 minutes
- LED-light 2 lamps
- Nominal power 386 W



K638BFX90



- Modern T-Shape Chimney Hood stainless steel
- Front Panel with Black Glass beveled edge.
- 1 Motor : 380 W, Aluminium alloy housing with metal propeller
- Gross extraction 1,188 m3/h.
| Net extraction rate 950 m3/h
- Honey Comb Stainless Steel Baffle tripple filter
- Removable Oil tray easily clean
- 4 Speeds
- Power off delay timer 3 and 7 minutes
- LED-light 2 lamps
- Nominal power 382 W



K635BFX90



- Modern T-Shape Chimney Hood
- 1 Motor : 400 W
- Gross extraction 1,250 m3/h.
- Net extraction rate 1,000 m3/h.
- 4 Speeds Touch Control
- LED bar lamp (1 x 7 W.)
- Power off delay timer (3 min , 7 min).
- Honey Comb Stainless Steel Baffle tripple filter
- Nominal power 407W



K632BFX90



- Modern T-Shape Chimney Hood 90 cm.
- Stainless steel body and chimney
- 1 Motor : 300W
- Manual control on black full width special magnetic acrylic panel
- Gross extraction 1,050 m3/h.
- Net extraction rate 850 m3/h.
- Honey Comb Stainless Steel Baffle tripple filter
- 3 speeds
- 2 x 2 watt LED lighting
- Nominal power 304W



K611BFX90



- Chimney Hood stainless steel
- 1 Motor : 380 W, Aluminium alloy housing
- Gross extraction 1,188 m3/h. | Net extraction rate 950 m3/h
- Honey Comb Stainless Steel Baffle tripple filter
- Removable Oil tray easily clean
- 3 Speeds
- LED-light 2 lamps
- Charcoal filter for circulation mode
- Nominal power 382 W



KV7118BFX90



- Chimney Hood [Arch shape Glass] stainless steel
- 1 Motor : 380 W, Aluminium alloy housing, heat resistant, rust proof
- Gross extraction 1,188 m3/h. | Net extraction rate 950 m3/h
- Honey Comb Stainless Steel Baffle tripple filter
- Removable Oil tray easily clean
- 3 Speeds
- LED-light 2 lamps
- Nominal power 382 W



Baffle Filter Chimney Hood

Wall Decoration Hood Baffle Filter

K638BFB90



- Modern Black color T-Shape Chimney Hood
- Front Panel with Black Glass beveled edge.
- 1 Motor : 380 W, Aluminium alloy housing with metal propeller
- Gross extraction 1,188 m3/h. | Net extraction rate 950 m3/h
- Honey Comb Baffle filter
- Removable Oil tray easily clean
- 4 Speeds
- Power off delay timer 3 and 7 minutes
- LED-light 2 lamps
- Nominal power 382 W



Chimney Hood

Wall Decoration Hood

KV737B90



- Chimney Hood Arch Shape Black Glass
- 1 Motor : 380 W, Aluminium alloy housing
- Gross extraction 1,188 m3/h. | Net extraction rate 950 m3/h
- 5 layers Aluminium filters
- Removable Oil tray easily clean
- 3 Speeds
- Power off delay timer 3 and 7 minutes
- LED-Bar
- Nominal power 385 W



K634B90



- Modern Black color T-Shape Chimney Hood
- 1 Motor : 380 W, Aluminium alloy housing, heat resistant , rust proof
- Gross extraction 1,188 m3/h. | Net extraction rate 950 m3/h
- 5 layers Aluminium filters
- 4 Speeds
- Power off delay timer 3 and 7 minutes
- LED-light 2 lamps
- Nominal power 382 W



K634B60



- Modern Black color T-Shape Chimney Hood
- 1 Motor : 330 W, Aluminium alloy housing, heat resistant , rust proof
- Gross extraction 1,050 m3/h. | Net extraction rate 850 m3/h
- 5 layers Aluminium filters
- 4 Speeds
- Power off delay timer 3 and 7 minutes
- LED-light 2 lamps
- Nominal power 332 W



K633B90



- Modern Black color T-Shape Chimney Hood
- 1 Motor : 330 W
- Gross extraction 1,050 m3/h. | Net extraction rate 850 m3/h
- 5 layers Aluminium filters
- 3 Speeds
- Power off delay timer 3 and 7 minutes
- LED-light 2 lamps
- Nominal power 332 W



FLAWLESS BLACK

Tweet Design

Elegant Black Glass Hood with fully Tempered glass panel High power motor, Made in Europe



Can be opened front cover to enhance grease exhaust power and easily removable filter with hold-open door closer system

- Elegant Black Glass Hood
- Fully Front panel Tempered Black Glass with Stainless steel exhaust housing
- 1 Motor : 250 W.
- Gross extraction 1,050 m³/h. Net extraction rate 850 m³/h
- Aluminum filters
- 3 speeds with intensive speed 10 minutes.
- 2 LED lamps
- Nominal power 252 W
- Made in Europe

TWEET 90B



TWEET 60B



Chimney Hood

Wall Decoration Hood

KC928X90

- Modern T-Shape Chimney Hood Front panel black glass stainless steel
- 1 Motor : 200 W.
- Gross extraction 1,020 m³/h.
- Stainless Steel Baffle filter
- Removable Oil Cup easily clean
- 3 speeds
- Power off delay timer 7 minutes
- 2 LED lamps
- Nominal power 202 W



KC927X90

- Modern T-Shape Chimney Hood stainless steel
- 1 Motor : 230 W
- Gross extraction 900 m³/h.
- Stainless Steel Baffle filter
- Removable Oil Cup easily clean
- 3 speeds
- Power off delay timer 3 and 7 minutes
- 2 LED lamps
- Nominal power 232 W



Chimney Hood

Wall Decoration Hood

K633X90

- Modern T-Shape Chimney Hood stainless steel
- 330 W, 1 motor
- Gross extraction 1,050 m³/h Net extraction rate 850 m³/h.
- 5 layers Aluminium filters
- 3 Speeds
- Power off delay timer 3 and 7 minutes
- 2 LED lamps
- Nominal power 332 W

K634XS90

- Modern T-Shape Chimney Hood stainless steel
- 380 W, Aluminium alloy housing heat resistant , rust proof
- Gross extraction 1,188 m³/h Net extraction rate 950 m³/h.
- 5 layers Aluminium filters
- 4 Speeds
- Power off delay timer 3 and 7 minutes
- 2 LED lamps
- Nominal power 382 W

K634XS60

- Modern T-Shape Chimney Hood Stainless steel
- 330 W, Aluminium alloy housing heat resistant , rust proof
- Gross extraction 1,050 m³/h. Net extraction rate 850 m³/h
- 5 layers Aluminium filters
- 4 Speeds
- Power off delay timer 3 an7 minutes
- 2 LED lamps
- Nominal power 332 W

KV737X90-1

- Chimney Hood [Arch shape Glass] stainless steel
- 380 W, Aluminium alloy housing
- Gross extraction 1,188 m³/h Net extraction rate 950 m³/h
- 5 layers Aluminium filters
- 3 Speeds
- Power off delay timer 3 and 7 minutes
- 2 LED Bar
- Nominal power 385 W

KV728X90-1

- Chimney Hood Classic Arch shape 90 cm
- Motor 330 W
- Gross extraction rate 1,050 m³/h.
- Net extraction rate 850 m³/h.
- 5 layers Aluminium filters
- Electronic control 3 Speeds
- LED bar lamp (1 x 5 W.)
- Power off delay timer 3 an7 minutes
- Nominal power 335 W

KV7269X90

- Chimney Hood [Classic Arch shape]
- Motor 280 W
- Gross extraction rate 850 m³/h.
- Net extraction rate 700 m³/h.
- 5 layers Aluminium filters
- 3 Speeds
- LED lamps (2 x 5 W.)
- Nominal power 290 W



Chimney Hood

Wall Decoration Hood

KV7269X60



- Chimney Hood Arch shape 60 cm.
- Motor 280 W
- Gross extraction rate 850 m3/h.
- Net extraction rate 700 m3/h.
- 5 layers Aluminium filters
- 3 Speed
- LED lamps (2 x 1.5 W.)
- Nominal power 283 W



KF1610X90AL



- Chimney Hood stainless steel
- 340 W, Aluminium alloy housing
- Gross extraction 1,200 m3/h
- Net extraction rate 1,000 m3/h.
- Aluminium filters
- 3 Speeds
- 2 Halogen Lamps
- Nominal power 380 W
- Made in Europe



K631X90



- Chimney Hood stainless steel
- 380 W, Aluminium alloy housing
- Gross extraction 1,188 m3/h .
- Net extraction rate 950 m3/h
- 5 layers Aluminium filters
- Speeds
- 2 LED lamps
- Nominal power 382 W



CEILING HOOD

ROOM FRESHENER Fullfill
perfection into your kitchen with
Ceiling hood



KBM60W120

- Ceiling Hood equip with motor
- Elegant Front panel with White tempered glass
- Motor : 400 W
- Gross extraction 1,200 m3/h.
- Net extraction rate 1,000 m3/h.
- Remote Control
- LED 2 bars (2 x 7 W))

*Please check Installation detail from seller



Island Hood

Island Hood

IS901X90



- Stainless Steel Island Hood with Straight glass
- 380 W, Aluminium alloy housing
- Gross extraction 1,188 m³/h.
- Net extraction rate 950 m³/h.
- Remote Control
- 4 LED lamps
- Nominal power 392 W
- The height of the ceiling should not exceed 247 cm



IS7010X90



- Stainless Steel T-Shape Island Hood
- Motor 340 W.
- Gross extraction 1,200 m³/h
- Net extraction rate 1,000 m³/h
- Soft Touch Electronic Control
- 3 speeds with intensive speed 10 minutes
- 4 LED lamps
- Nominal power 344 W
- The height of the ceiling should not exceed 286 cm
- Made in Italy



IS738XS90



- Stainless Steel Island Hood with Arch Shape Glass
- 380 W, Aluminium alloy housing
- Gross extraction 1,188 m³/h
- Net extraction rate 950 m³/h
- 3 Speeds
- Automatic swith off 3,6,9,15 and 15 minute
- 4 LED lamps
- Nominal power 386 W
- The height of the ceiling should not exceed 276 cm



Standard Hood

Standard Hood

2740X60 (60 cm.) | 2740X90 (90 cm.)

- Stainless steel Standard Hood
- 2 Motors : 125 W
- Gross extraction rate 520 m³/h.
- Net extraction rate 460 m³/h
- 2 aluminum filters.
- > Model 2740X60 - 2 pcs
- > Model 2740X90 - 3 pcs
- 3 speeds
- 2 LED lamps (2 x 4 Watt)
- Re-circulated mode applicable .
- Nominal powe 258 W
- Made in Europe



2740X60



2740X90



2950X60 (60 cm.) | 2950X90 (90 cm.)

- Stainless steel Standard Hood
- 2 Motors : 85 W
- Gross extraction rate 450 m³/h.
- Net extraction rate 380 m³/h
- 5 layers Aluminium filters
- Push button control
- 3 speeds.
- 2 LED lamps (2 x 2 watts)
- Re-circulated mode applicable.
- Nominal powe 174 W



2950X60



2950X90



BUILT-IN HOOD

Seamless Classy Design
Built-in Hood



Built-in hood our solutions fit seamlessly in your kitchen with high performance motor to "exhaust smoke and get rid of smell" with removeable filters

SP745

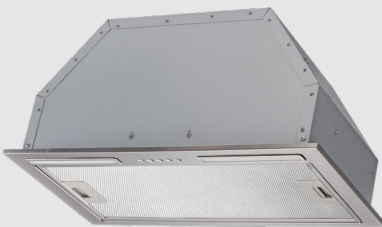

- Stainless steel Built-In Hood
- 1 Motor : 320 W aluminium housing
- Gross extraction rate 1,050 m3/h. Net extraction rate 900 m3/h.
- 5 layers aluminum filter.
- 3 speeds.
- 2 LED lamps
- Nominal power : 322 W



SP545

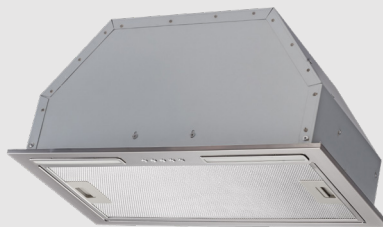

- Stainless steel Built-In Hood
- 1 Motor : 320 W aluminium housing
- Gross extraction rate 1,050 m3/h Net extraction rate 900 m3/h.
- 5 layers aluminum filter.
- 3 speeds.
- 2 LED lamps
- Nominal power : 322 W



SP541



- Stainless steel Built-In Hood
- 1 Motor : 155 W aluminium housing
- Gross extraction rate 550 m3/h Net extraction rate 480 m3/h .
- 5 layers aluminum filter.
- 3 speeds.
- 2 LED lamps
- Nominal power : 157 W



Slim Line Hood

Slim Line Hood Mounted inside Kitchen Cabinet

SL226



- Automatic Slim line Hood
- Stainless Steel Front panel
- motor : 155 W
- Gross extraction rate 550m3/h. Net extraction rate 480 m3/h.
- Can use extraction mode only.
- 2 speeds
- 2 lamps (2 x 40 W.)
- Nominal power 250 W



Slim Line Hood

Slim Line Hood Mounted inside Kitchen Cabinet

SL608GM/X60



- Automatic Slim line Hood with Exhaust Air mode
- Stainless Steel Front panel
- 1 motor : 250W
- Gross extraction rate 1,000 m3/h.
Net extraction rate 800 m3/h.
- Aluminum filter.
- Automatic operate when move front panel
- 3 speeds.
- 2 halogen lamps
- Nominal power 290 W
- Made in Europe



SL360W/X60



- Automatic Slim line Hood with Exhaust Air mode
- Stainless Steel Front panel
- 1 motor : 115 W
- Gross extraction rate 480 m3/h.
Net extraction rate 420 m3/h.
- Aluminum filter.
- Automatic operate when move front panel
- 3 speeds.
- 2 lamps
- Nominal power 195 W
- Made in Europe



SL206



- Automatic Slim line Hood with Recirculation Mode Applicable.
- Stainless Steel Front panel
- 2 motor : 85 W
- Gross extraction rate 450 m3/h.
Net extraction rate 380 m3/h.
- 2 metal grease filters and Charcoal filter
- 2 speeds
- 2 lamps
- Nominal power 250 W



Hood Accessories

Hood Accessories

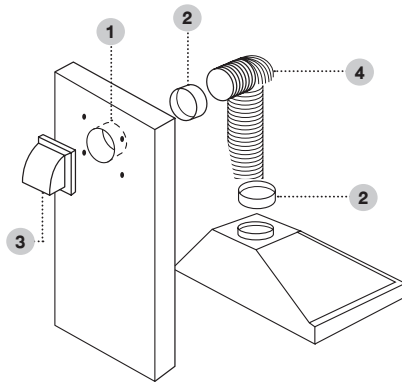

1 WALL TUBE

Built in wall tube
CONNECTOR

- MWT150 (150 mm. 6 inch)
- MWT125 (125 mm. 5 inch)



2 CONNECTOR

Flexible Duct Connector
WALL TUBE & AIR OUTLET

- MCN150 (150 mm. 6 inch)
- MCN125 (125 mm. 5 inch)



3 AIR OUTLET

Stainless Steel AISI 304



- FCR150X (150 mm. 6 inch)
- FCR125X (125 mm. 5 inch)
- FCR100X (100 mm. 4 inch)



- MAR150WH (150 mm. 6")
- MAR125WH (125 mm. 5")



- MAG150WH (150 mm. 6")
- MAG125WH (125 mm. 5")
- MAG100WH (100 mm. 4")



4 FLEXIBLE DUCT EXHAUST DUCT FOR HOOD

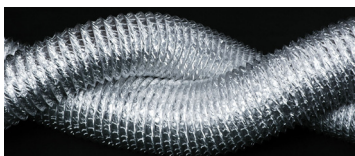

Size 4 INCH

- Long 1 m. SM-B037
- Long 2 m. SM-B151
- Long 3 m. SM-B152
- Long 10 m. SM-B153

Size 5 INCH

- Long 1 m. SM-B100
- Long 2 m. SM-B154
- Long 3 m. SM-B155
- Long 10 m. SM-B156

Size 6 INCH

- Long 1 m. SM-B055
- Long 2 m. SM-B157
- Long 3 m. SM-B158
- Long 10 m. SM-B159



04

| Dishwasher and Dish Dryer

A new definition of hygiene

HALLMARK OF CLEANLINESS

Offering more excellent washing function with latest in dish-cleaning technologies

LATEST IN DISH-CLEANING TECHNOLOGIES



PUREBEAM REDUCE BACTERIAL ACCUMULATING AND STOP ITS GROWTH AND REDUCE UNPLEASANT SMELL

MEX dishwasher is designed with dual technologies PUREBEAM [UV+ION TEACH] UV feature prevents bacterial growth and reduce bacterial remaining after washing cycle. It disinfects the load of UV technology built into machine and automatically sterilizing each load before unload.



ION TECH REDUCE UNPLEASANT SMELL

MEX dishwasher are engineered to the high standards with high technology. Natural ION TECH spreads negative ions inside the dishwasher. These negative ions neutralize particles of unpleasant smell. As well as ION TECH removes odors caused by dirty dishes, in order to reduce unpleasant smell after Dishwasher operating.

HIGH QUALITY
PRODUCT
MADE IN
EUROPE



FLEXIBLE BASKETS AND RACKS FOR MORE SPACE TO ENJOY

HIGH
CAPACITY

CONTAIN MORE KITCHEN UTENSILS
SUPPORT LARGE SIZE OF POT AND PAN.



The 3rd rack provide perfect extra space for loading utensils, cutlery and silverware, it is composed of two pieces which can be taken out from the 3rd rack to obtain more space for the dishes in the upper basket.



Upper Basket is easily adjustable with 3 steps level height to max space when washing tall items.



The Low basket is more comfortable with folding racks on it that each section can be folded separately and give more room for large items.



Removable Cutlery Basket



POWERFUL WASHING PROGRAMS



Dual Pro Wash

Advanced pump technology allows for wash to be cleaned at two separate water pressure. Baked on food does not stick at the bottom while the delicate glasses in the top are gently being washed.



Jet Wash

With this fast program, you can clean the dishes with small dirt like soiled coffee, milk and tea just within 14 min. It cleans your dishes with max 4 sets of standard table utensil.



Smart Wash

Turbidity sensor detects the amount of turbidity in water and adjusts the washing cycle parameters [temperature, duration, amount of water] automatically.



Quick Clean

Quick Clean Program with advance cleaning in only 50 min without diverter and achieves A class cleaning performance. You can save time with this program.



Steam Wash

Steam wash technology softening the most stubborn dirt by steam power. High temperature and directly applied steam ensure perfect hygiene and gentle cleaning for your sensitive dishes.

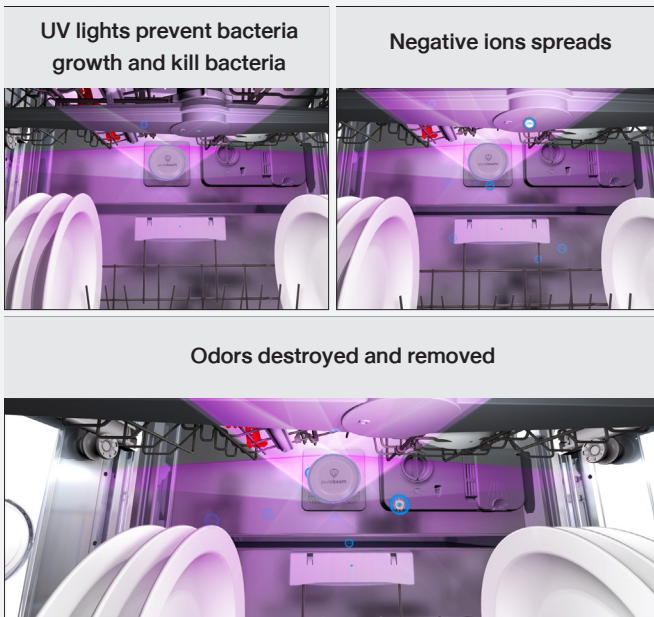

BOOST PERFORMANCE WITH EXTRA FUNCTIONS

Extra Hygienic Wash Extra hygiene ensures a maximum hygiene with high Temperature washing. It increases water temperature at final rinse step in order to eliminate bacteria up to 99.99%

Extra Rinse Extra rinse function adds an extra rinse step to achieve more hygienic washing. Program duration is increased between minimum 4% and maximum 16% .

Extra Dry For better drying performance, MEX dishwasher provide extra drying function which it increases water temperature at final rinse step and drying step duration up to 10 minutes

Extra Silent Reduce noise during operating

Extra Fast Shorten total operating time with increase of temperature and pressure. Make sure all dishes and utensil are cleaned in short time.



MORE OPTIONS MORE CONVENIENT



Half Load

Eco Friendly Half Load technology provides high washing performance when dishwasher is not fully loaded only lower basket or upper basket or both are used. It can run with reduced water and less energy consumption. Half Load technology is a load option to saves electric and water supply Bills.



Tablet Function

With this option, water reaches optimum temperature to dissolve and combined detergent ideally and eliminates such drawbacks and assures maximum performance when tablet detergents are used.



Delay Timer

Conveniently set up the delay start time in advance 1 - 24 hours. You can set up the dishwasher in advance with preferred program and schedule.



Child Lock

Child lock option never allows your children to play with your dishwasher. It allows you to lock the buttons on the control panel to be able to restrict the functionality of buttons.

FULLY INTEGRATED BUILT IN DISHWASHER

Sleek and Smooth integrated in to counter



NEW ARRIVAL!

LVB6533



*Not include front panel of furniture

Experience the next level of stylish luxury with a New Built-in Dishwasher sliding door panel type, which invent every design can be possible together with efficiency cleaning of Ion Technology and plus 3 extra functions.

- 60 cm. / Inside body Stainless Steel
- Ion Tech technology to reduce unpleasant odor

8 Washing program Plus 3 extra function

- | | |
|------------------------------------|----------------|
| > Eco (Standard Program) | > Extra Dry |
| > Smart 60-70° C | > Extra Silent |
| > Steam wash | > Extra Fast |
| > Hygiene 70° C | |
| > Super 50 min 65° C (Quick Clean) | |
| > Dual Pro Wash 60° C | |
| > Quick 30 min 40° C | |
| > Mini 14 min (Jet Wash) | |

- Half Load function that saves energy and water
- A delay start time of between 1 hour and 19 hours
- Touch control
- LED display with button control
- Rinse-aid, salt use, washing cycle and end of cycle indicator light
- 13 place settings
- 2 baskets and 3rd rack (adjustable upper basket

with foldable racks) with a removable cutlery basket

- > The Lower Basket is more comfortable with folding racks on it that each section can be folded separately.
- > The Upper Basket is easily adjustable with 3 step level height to maximize space when washing tall items. There are also adjustable mug selves making more flexibility to fit tall glasses, mugs and smaller cups
- > The 3rd Rack provides perfect extra space for loading
- > Removable cutlery basket

- Aqua Stop
- 4 interior lighting
- Anti-Bacterial Filter
- Standard program water consumption : 9 liter / cycle
- Energy efficiency : A+++
- Cleaning efficiency: A
- Drying efficiency class : A
- Noise 45 dB
- Made in Europe



Dishwasher

Dishwasher

DV813DX



- Stainless steel Dark Inox Anti-fingerprint
- 60 cm. Free standing stainless steel Dishwasher
- Purebeam Technology

8 Washing program Plus 4 extra functions

- > Jet Wash 14 min
- > Quick 30 min 40° C
- > Eco
- > Dual Pro Wash 60° C
- > Super 50 min 65° C (Quick Clean)
- > Smart 30° C - 50° C
- > Smart 50° C - 70° C
- > Steam Wash
- > Extra Hygienic Wash
- > Extra Dry
- > Extra Silent
- > Extra Fast

- A delay start time of between 1 hour and 24 hours
- LED display with Touch control which can show Operating Status, washing Circle and other set up.
- Rinse-aid, salt use, end of cycle indicator light
- Adjustable Basket various functions
- > Removable Upper Basket 2 in1
- > 3 step levels height upper basket, foldable racks
- > Large lower basket with 2 foldable racks
- > Removable cutlery basket
- Anti-Bacterial Filter
- Overflow Leakage and Heater Protection
- Standard program water consumption 9 liter / cycle



DI813DG



- Dark Gray Color
- 60 cm. Free standing dishwasher
- Ion Tech technology

8 Washing program Plus 3 extra functions

- > Prewash
- > Quick 30 min 40° C
- > Eco
- > Super 50 min 65° C (Quick Clean)
- > Daily 65° C (Hybrid Wash)
- > Smart 30° C - 50° C
- > Smart 50° C - 60° C
- > Smart 60° C - 70° C
- > Extra Hygienic Wash
- > Extra Rinse
- > Extra Dry

- A delay start time of between 1 hour and 24 hours
- LED display with button control show Operating-Status, washing Circle and other set up.
- Rinse-aid, salt use, and end of cycle indicator light
- Adjustable Basket various functions
- > Removable Upper Basket
- > 3 step levels height upper basket ,foldable racks
- > Large lower basket with 1 foldable rack.
- > Removable cutlery basket
- Anti-Bacterial Filter
- Standard program water consumption 9 liter / cycle



DK612W



- White
- 60 cm. Free standing dishwasher.

6 Washing Program

- > Prewash
- > Quick 30 min 40° C
- > Eco
- > Super 50 min 65° C (Quick Clean)
- > Intensive 65° C
- > Hygiene 70° C

A delay start time for 3 , 6 and 9 hours can be selected

- Rinse-aid, salt use, and end of cycle indicator light
- Knob and Button Control
- Baskets
- > Adjustable 3 levels Top basket
- > foldable racks
- > Large lower basket
- > Removable cutlery basket



Dishwasher Salt

Contain 1.5 kgs

Dish Dryer

Free Stand Dish Dryer

DM60E-1



- 4 programs
- > Automatic program
- > Hot Air program
- > Drying program
- > Storage/maintain program
- Gross capacity 60 liters
- Capacity (dishes) 10 pcs
- Temperature 70 .C (+/- 5.C)
- Touch Control
- Child safety loc
- Auto Stop when cover is opened
- Stainless steel AISI304 tableware rack
- Effectively reduce bacteria and reduce odour

DM60B-1

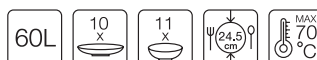

- Gross capacity 60 liters
- Capacity (dishes) 10 pcs
- Knob Control
- Timer control, working duration 10-60 minutes
- Temperature 70 .C (+/- 5.C)
- Stainless steel AISI304 tableware rack
- Auto Stop when cover is opened
- Effectively reduce bacteria and reduce odour



05

| Composite Sink

More stylish choices to lighten
your daily chores



reddot design award
best of the best 2021

METRIX BY elledi

DIALOGO

BEST EVER KITCHEN WORKSTATION

Essential function, style, elegance
and sophistication in the Kitchen

DIALOGO is the best innovative design for ceramic
kitchen sink certified by the reward BEST of the BEST
from Red Dot Design Award 2021

DIALOGO Workstation is next level of combinations of
latest innovation and essential function design to create
a design element to fit for your functional usages in the
kitchen with elegance accessories for food preparation,
cleaning and storage.





Kitchen sink series DIALOGO and TEM are composed of Ceramic nanoparticles with a mix of 6 innovative acrylic resins which created "KERATEK" New Innovative Patented material from Metrix which colors are more vivid and intense than ever before. An ultracompact surface that is even smoother to the touch.



With High Innovative material DIALOGO and TEM are raised up the premium quality with stylish and strong kitchen sinks.

With ultracompact surface of KERATEK PLUS provided the stain-resistant which prevent the stain from coffee, wine, bleach, fats and food acids. Easily Clean and its material is safe for environment.

Ceramic Composite Sink

DIALOGO-ST-K86 | Black



**1 Bowl Ceramic Sink Smart Edge
(6 mm. thickness) with Drainer Cover**

- Overall Dimension 86 x 46 cm.
 - Big bowl size 69.4 x 39.6 cm.
 - Bowl depth 22 cm.
 - Cutting Size 84 x 44 cm.
 - Pop-up Drainer size 3.5 inches
- Black color with overflow and P-TRAP



DIALOGO-ST-K83 | Crayon



DIALOGO-ST-K81 Night Green



METRIX BY **elleci**

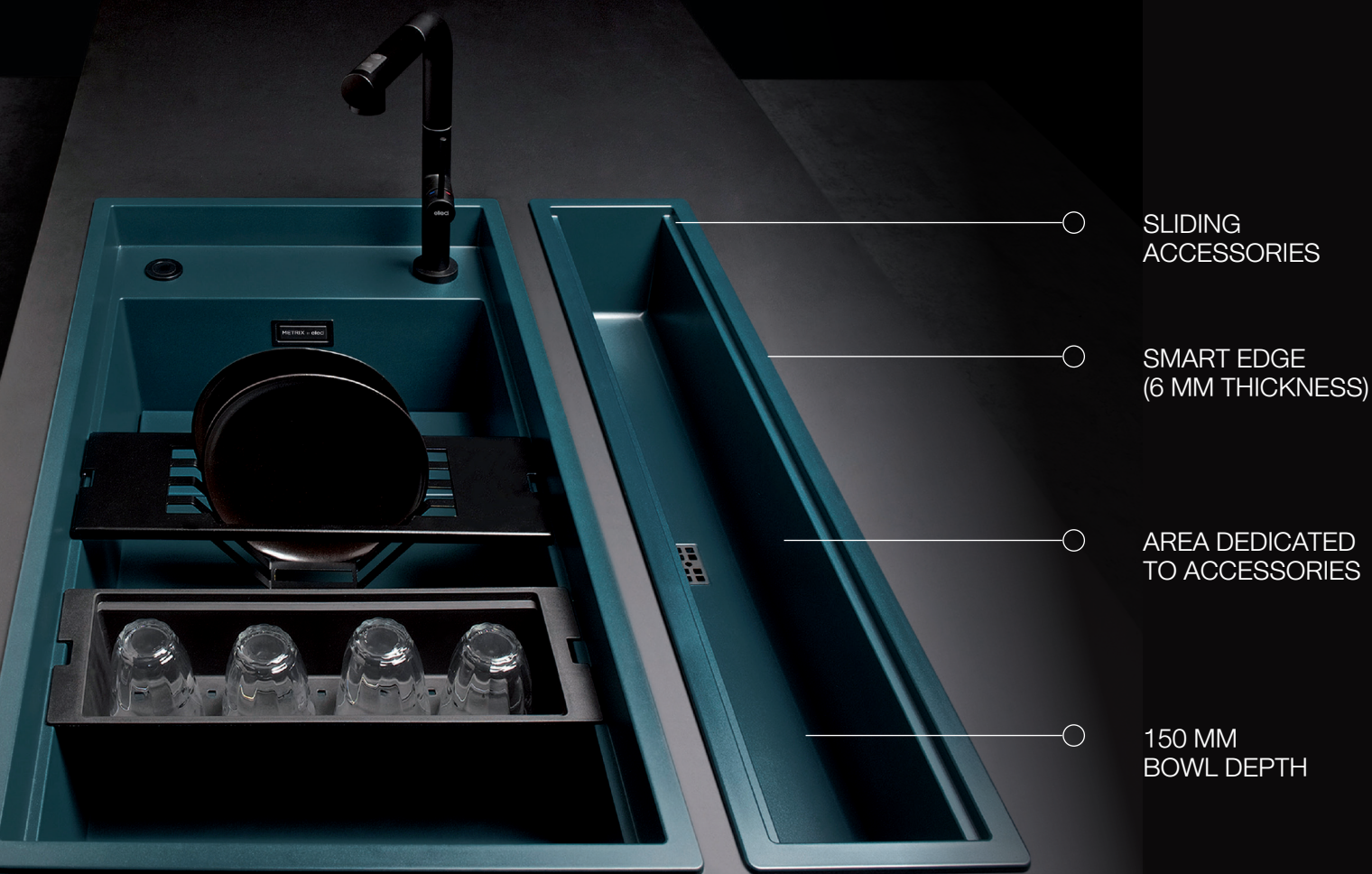

Ceramic Composite Sink

METRIX BY **elleci**

DIALOGO-TR-K86 | Black



1 Bowl Ceramic Sink Smart Edge 6 mm. Thickness

- Overall Dimension 86 x 18 cm.
- Bowl size 82 x 11.9 cm.
- Bowl depth 15 cm.
- Cutting Size 85 x 17 cm.



DIALOGO-TR-K83 | Crayon



DIALOGO-TR-K81 | Night Green



DIALOGO Accessories

Accessories for Ceramic Sink DIALOGO

METRIX BY **elleci**



DIALOGO-COLANDER

Plastic {PP} Colander Black Color
Size 40.8 x 13.8 x 8.4 cm.



DIALOGO-TY408

Aluminum Colander Black Color
Size 40.8 x 13.7 x 1.1 cm.



DIALOGO-TY204

Aluminum Colander Black Color
Size 20.4 x 13.7 x 1.1 cm.

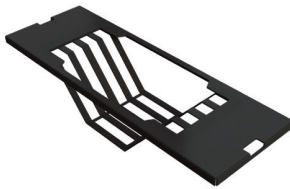

DIALOGO-DRAINER

Aluminum Drainer Black Color
Size 40.8 x 13.7 x 1.1 cm.

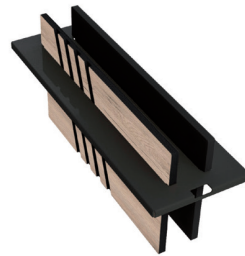

DIALOGO-CB-KIT2

Black Aluminum Cut board [HPL]
Size 40.8 x 13.7 x 18 cm.



RM440

Metal covered Silicone Roll Matt
Size 44.0 x 30.0 x 10 cm.

DIALOGO-TY204 / DIALOGO-CB-KIT2

DIALOGO-TY408



RM440

DIALOGO-COLANDER

DIALOGO-DRAINER





DIALOGO WORKSTATION

DIALOGO Workstation is next level of combinations of latest innovation and essential function design to create a design element to fit for your functional use in the kitchen with elegance accessories for food preparation, cleaning and storage.

METRIX BY elleci

DIALOGO Kitchen Work Station CERAMIC SINK WORK STATION SET

DIALOGO-ST-K86SET | Black



DIALOGO-ST-K83SET | Crayon



DIALOGO-ST-K81SET | Night Green

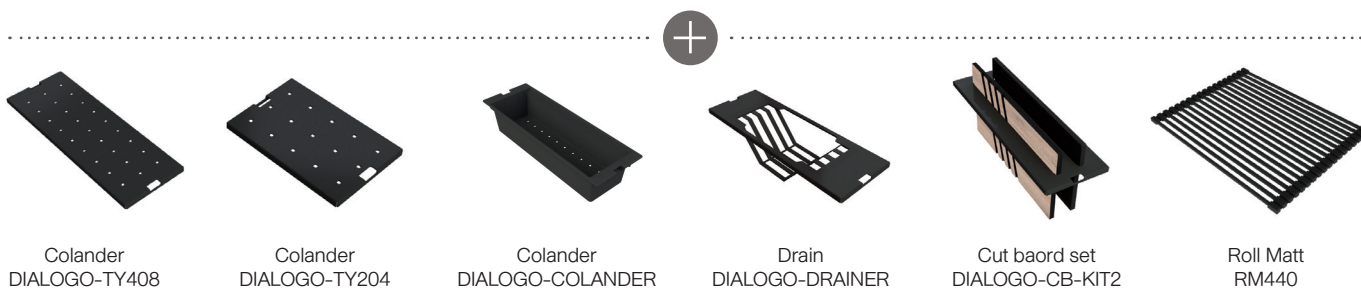

Standard



Undermount



Thickness
6 mm.



Large Bowl



Sliding Row



Square shape Overflow

MADE IN ITALY



WATER REPELLENT AND STAIN RESISTANT

Keratek Plus With a zero-porosity surface that ensures maximum hygiene and amazing resistance to staining agents



THERMAL SHOCK RESISTANCE

METRIX has been designed for thermal shock resistance of rapidly changing of temperature from hot to cold water. The sink will not crack or damage when pouring hot water and cold water.



IMPACT RESISTANCE

Metrix Kitchen Sink maintains quality and elegance appearance with innovation of mixed materials and casting production made this sink has higher heat and crash resistance than other composite materials.



UV PROTECTION

The mixed composite material of Ceramic sink can protect its color surface from UV radiation, so the sink color will not fade away and maintain its original color. However, we recommend installing the sink indoors.



SMOOTHER AND HARDER

With Innovation of GPS provided Ceramic nanoparticles well blending with acrylic resins which made surface of the sink touching smoothly and reinforce the scratching resistance.



ANTI-BACTERIA

METRIX highly considers the hygiene of the user as an important matter. KETATEX PLUS created a zero-porosity surface that ensures maximum hygiene and amazing resistance to staining agents, living everyday life has never been more exciting.

Ceramic Sink

METRIX

TEM100BL | Black



1 Bowl Ceramic Sink

- Size 75.6 x 45.6 cm.
- Bowl size 70 x 40 cm.
- Bowl depth 20 cm.
- Cutting Size 74.5 x 44.5 cm.
- 3.5 inched Drianer ,Overflow and P-TRAP

MADE IN ITALY

TEM100CY | Crayon



TEM100NG | Night Green





METRIX

Smooth with Stylish Charming a unique Kitchen Sink

The evolution of Granite Sink NUOVO+GRANITO
Manufactured with modern technology from a world-class factory in Italy. Outstanding in both design and quality, combining the strength of high-quality natural granite with acrylic resin through the process of the granite powder casting by rotating hot molds, so that, the particles of the granite powder are distributed evenly to enhance heat and thermal shock resistance.
Additionally, it mixed with "Silver Ion" for anti-bacteria.



THERMAL SHOCK RESISTANCE

METRIX has been designed for thermal shock resistance of rapidly changing of temperature from hot to cold water. The sink will not crack or damage when pouring hot water and cold water.



IMPACT RESISTANCE

Metrix Kitchen Sink maintains quality and elegance appearance with innovation of mixed materials and casting production made this sink has higher heat and crash resistance than other composite materials.



ANTI-BACTERIA

METRIX highly considers the hygiene of the user as an important matter. With modern technology of GRANIEK ANDMETALTEK to reduce bacteria accumulation and add Silver Ion to prevent Bacterial growth



UV PROTECTION

The mixed composite material of granite sink can protect its color surface from UV radiation, so the sink color will not fade away and maintain its original color. However, we recommend installing the sink indoors

METRIX

THE GLOBE SERIES

creates a large workspace suitable for big pans and baking trays.

"Discover the Freedom to make a creative kitchen"
GLOBE, a new design granite sink, minimalist style is combined with classic European modern style. Make your kitchen different. Kitchen sink offers a big deep bowl design to serve various functions and accommodates many large containers.

MADE IN ITALY

GLOBE Series Granite Sink

GLOBE100BL | Black



1 Bowl Granite Sink

- Overall Dimension 83.8 x 48.3 cm.
- Bowl size 74.5 x 40.8 cm.
- Depth 23.5 cm.
- Drainer 3.5 inches with overflow and P-TRAP

GLOBE100WH | White



1 Bowl Granite Sink

- Overall Dimension 83.8 x 48.3 cm.
- Bowl size 74.5 x 40.8 cm.
- Depth 23.5 cm
- Drainer 3.5 inches with overflow and P-TRAP

CB406 | Cut Board



Multifunction Cut Board color OLMO

- Coating with HPL (High Pressure Laminate)
Water, humidity and heat resistance.
- Safe, Food Grade
- Size 28.0 x 40.6 cm. Thickness 0.8 cm.
- Applicable only model GLOBE100BL,
GLOBE100WH

METRIX

COMPACT DRAIN

Special Drain system for RIM Series

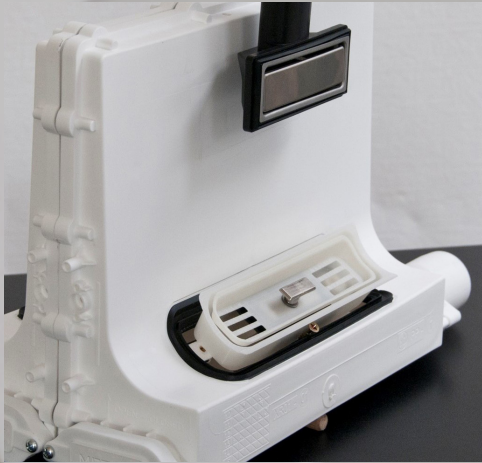

MADE IN ITALY

RIM Series
Granite Sink

RIM21CE | Cement color



Granite Sink 2 Bowls 1 Drain

- Overall Dimension 116 x 51.5 cm.
- Bowl size 33 x 41.5 cm. Depth 21 cm.
- Cutting Size 114 x 48 cm.
- Compact Drain system

RIM11CE | Cement color



Granite Sink 2 Bowls 1 Drain

- Overall Dimension 100 x 51.5 cm.
- Bowl size 46.5 x 41.5 cm. Depth 21 cm.
- Cutting Size 98 x 48 cm.
- Compact Drain system

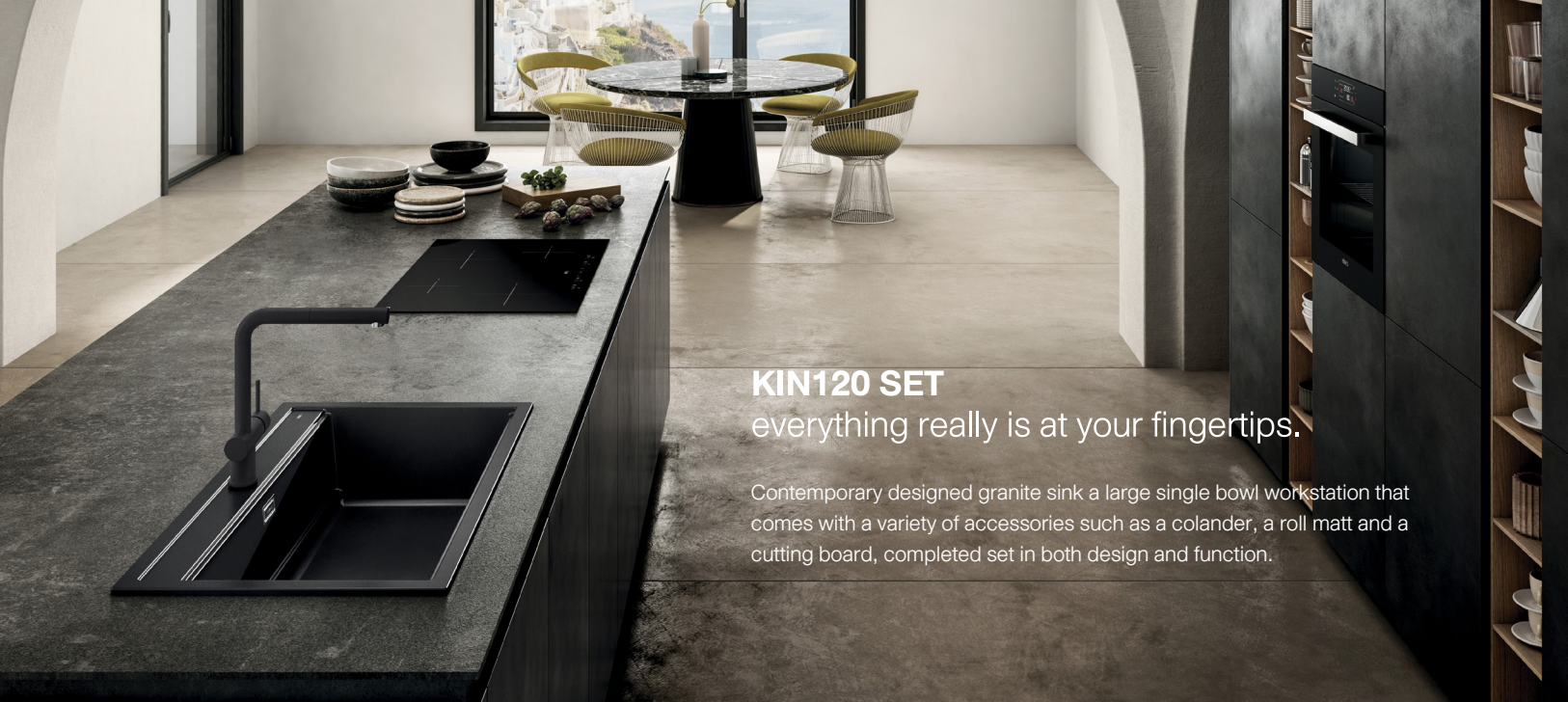

KIN120 SET everything really is at your fingertips.

Contemporary designed granite sink a large single bowl workstation that comes with a variety of accessories such as a colander, a roll matt and a cutting board, completed set in both design and function.

KIN120 SET Kitchen Work Station Granite Sink Work Station Set

KIN120BL-BL | SINK KITCHEN SET



1 BOWL GRANITE SINK

- 1 bowl granite sink countertop
- Black
- Bowl depth 20 cm.
- Overall Dimension 86 x 51 cm.
- Bowl size 79.6 x 32cm.
- Cutting Size : 84 x 48 cm.
- 3.5 inched Drainer, Overflow and P-TRAP

Free Accessories!

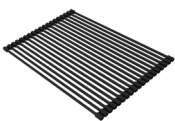

Roll Matt
RM500



Cut Board
Color Nero | CB383BL



Colander
CL380

KIN120BL-OA SINK KITCHEN SET



1 BOWL GRANITE SINK

- 1 bowl granite sink countertop
- Black
- Bowl depth 20 cm.
- Overall Dimension 86 x 51 cm.
- Bowl size 79.6 x 32cm.
- Cutting Size : 84 x 48 cm.
- 3.5 inched Drainer, Overflow and P-TRAP

Free Accessories!

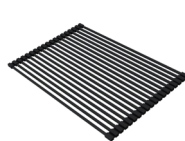

Roll Matt
RM500



Cut Board
Color Quercia | CB383OA



Colander
CL380

KIN Series

Granite Sink

METRIX

■ **KIN21**

KIN21BL | Black



Granite Sink 2 Bowls 1 Drain

KIN21TN | Titanium Color



- Overall Dimension 116 x 51 cm.
- Bowl size 32.5 x 42.1 cm. Depth 20 cm.
- Cutting Size 114 x 48 cm.
- Drain 3.5" with overflow and P-TRAP



■ **KIN20**

KIN20BL | Black



Granite Sink 2 Bowls

KIN20TN | Titanium



- Overall Dimension 86 x 51 cm.
- Bowl size 36.5 x 42.1 cm. Depth 20 cm.
- Cutting Size 84 x 48 cm.
- Drain 3.5" with overflow and P-TRAP



■ **KIN11**

KIN11BL | Black



Granite Sink 1 Bowl 1 Drain

KIN11TN | Titanium



- Overall Dimension 100 x 51 cm.
- Bowl size 47.8 x 42.1 cm. Depth 20 cm.
- Cutting Size 98 x 48 cm.
- Drain 3.5 " with overflow and P-TRAP



■ KIN100

KIN100BL | BLACK



KIN100TN | Titanium

**Granite Sink 2 Bowls 1 Drain**

- Overall Dimension 79 x 50 cm.
- Bowl size 72 x 40 cm. Depth 20 cm.
- Cutting Size 77 x 48 cm.
- Drain 3.5 " with overflow and P-TRAP

MADE IN ITALY

■ KIN15

KIN15BL | BLACK



KIN15CE | CEMENT COLOR

**Granite Sink 1 Bowl**

- Overall Dimension 57 x 50 cm.
- Bowl size 50 x 40 cm.
- Cutting Size 55 x 48 cm.
- Drain 3.5 " with overflow and P-TRAP

MADE IN ITALY

METRIX

Undermount KIN Series**Undermount Granite Sink**

■ KIN100U

KIN100UBL | BLACK



KIN100UCE | CEMENT COLOR

**Granite Sink 1 Bowl**

- Overall Dimension 76 x 44 cm.
- Bowl size 72 x 40 cm. Depth 20 cm.
- Cutting Size 72.5 x 40.2 cm.
- Drain 3.5 " with overflow and P-TRAP

MADE IN ITALY

■ KIN15U

KIN15UBL | BLACK



KIN15UCE | CEMENT COLOR

**Granite Sink 1 Bowl**

- Overall Dimension 54 x 44 cm.
- Bowl size 50 x 40 cm. Depth 20 cm.
- Cutting Size 50 x 40 cm.
- Drain 3.5 " with overflow and P-TRAP

MADE IN ITALY

NES Series Granite Sink

METRIX

■ NES21

NES21BL | Black

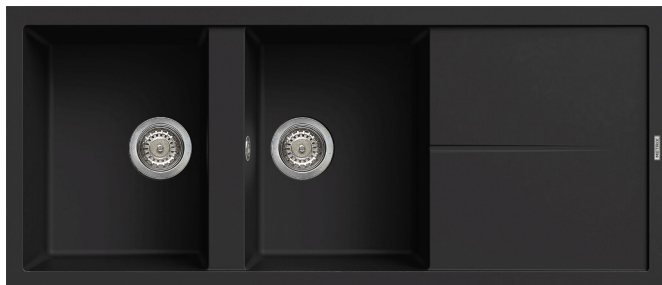

Granite Sink 2 Bowls 1 Drain

NES21CE | CEMENT COLOR



- Overall Dimension 116 x 50 cm.
- Bowl size 32.4 x 43 cm.
- Depth 20 cm.
- Cutting Size 114 x 48 cm.
- Drain 3.5 " with overflow and P-TRAP

MADE IN ITALY

■ NES20

NES20BL | Black



Granite Sink 2 Bowls

NES20CE | CEMENT COLOR



- Overall Dimension 86 X 50 cm.
- Bowl size 45 x 43.4 and 31.4 x 38.5 cm.
- Depth 21 cm.
- Cutting Size 84 x 48 cm.
- Drain 3.5 " with overflow and P-TRAP

MADE IN ITALY

■ NES11

NES11BL | Black



Granite Sink 1 Bowl 1 Drain

NES11CE | CEMENT COLOR



- Overall Dimension 100 x 50 cm.
- Bowl size 48 x 43.5 cm. Depth 20 cm.
- Cutting Size 98 x 48 cm.
- Drain 3.5 " with overflow and P-TRAP

MADE IN ITALY



CURVING DESIGN MODERN
VICTORIAN AESTHETIC

DELLA450 | Cream

DELLA450 Granite kitchen sink is designed to be in the vibe of Victoria aesthetic and modern classic style.

- Dimension 86.4 X 50.3 cm.
- Bowl size 48 x 45 and 30 x 45 cm.
- Depth 22.5 cm.
- Cutting Size 84 x 49 cm.
- Drain 3.5 " with overflow and P-TRAP



MOS Series Granite Sink

MOS21BL | Black



MOS21TN | Titanium



**Granite Sink
2 Bowls 1 Drain**

- Overall Dimension 116 x 50 cm
- Bowl size 33 x 40 cm. Depth 20 cm.
- Cutting Size 114 x 48 cm.
- Drain 3.5 " with overflow and P-TRAP



MOS11BL | Black



MOS11TN | Titanium



**Granite Sink
1 Bowl 1 Drain**

- Overall Dimension 100 x 50 cm.
- Bowl size 48 x 35.8 cm. Depth 20 cm.
- Cutting Size 98 x 48 cm.
- Drain 3.5 " with overflow and P-TRA





06

Stainless Steel Sink

The perfect blend of design, performance and sheer quality

**AISI
304**

**STAINLESS
STEEL
AISI 304**

MEX sinks are made of AISI 304 stainless steel, good grade, which is resistant to corrosion in acidic, alkaline, solvents that may be exposed from washing vegetables, fruits, meat, milk and dishwashing liquid. MEX therefore uses only AISI 304 stainless steel for its sinks for durability for safety of the family

SC Series Modern Square S/S Sink

SCD1202 | SCS1202



SC872



	SCD1202 (Left B./ Right D.) SCS1202 (Right B/Left D.)	SC872	FREE <ul style="list-style-type: none"> • Drainer 3.5" Big Basket • with overflow P-TRAP (P34PP) <p>* NOT INCLUDED TAP</p>
Type	2 Bowls 1 Drain	2 Bowls	
Overall Dimension	120 x 50 cm. Thick 1.0 mm.	87 x 50 cm. Thick 1.0 mm.	
Bowl size	45 x 40, 36 x 40 cm. Depth 20 cm.	45 x 40, 34 x 40 cm. Depth 20 cm.	
Cutting Size	118 x 48 cm.	85 x 48 cm.	

SCD1001 | SCS1001



SCD861 | SCS861



SC82



	SCD1001 (Left B./ Right D.) SCS1001 (Right B/Left D)	SCD861 (Left B./ Right D.) SCS861 (Right B/Left D)	SC82	FREE <ul style="list-style-type: none"> • Drainer 3.5" Big Basket • with overflow P-TRAP (P31PP) <p>* NOT INCLUDED TAP</p>
Type	1 Bowl 1 Drain	1 Bowl 1 Drain	1 Bowl	
Overall Dimension	100 x 50 cm. Thick 1.0 mm.	86 x 50 cm. Thick 1.0 mm.	82 x 50 cm. Thick 1.0 mm.	
Bowl size	55 x 40 cm. Depth 20 cm.	45 x 40 cm. Depth 20 cm.	77 x 40 cm. Depth 20 cm.	
Cutting Size	98 x 48 cm.	84 x 48 cm.	80 x 48 ƳU.	

SC60



SC50



SC45



	SC60	SC50	SC45	FREE <ul style="list-style-type: none"> • Drainer 3.5" Big Basket • with overflow P-TRAP (P31PP) <p>* NOT INCLUDED TAP</p>
Type	1 Bowl	1 Bowl	1 Bowl	
Overall Dimension	60 x 50 cm. Thick 1.0 mm.	50 x 50 cm. Thick 1.0 mm.	45 x 50 cm. Thick 1.0 mm.	
Bowl size	55 x 40 cm. Depth 20 cm.	45 x 40 cm. Depth 20 cm.	40 x 40 cm. Depth 20 cm.	
Cutting Size	58 x 48 ƳU.	48 x 48 cm.	43 x 48 cm.	

Undermount Series

Undermount Kitchen Sink



BSC822



	BSC822	FREE
Type	2 Bowls	<ul style="list-style-type: none"> • Drainer 3.5" Big Basket • with overflow P-TRAP (P34PP) ★ NOT INCLUDED TAP
Overall Dimension	86 x 44 cm. Thick 1.0 mm.	
Bowl size	45 x 40, 34 x 40 cm. Depth 20 cm	
Cutting size	82.5 x 40.5 cm.	

BSC77



	BSC77	FREE
Type	1 Bowl	<ul style="list-style-type: none"> • Drainer 3.5" Big Basket • with overflow P-TRAP (P32PP) ★ NOT INCLUDED TAP
Overall Dimension	81 x 44 cm. Thick 1.0 mm	
Bowl size	77 x 40 cm. Depth 20 mm.	
Cutting Size	77 x 40 cm.	

BL33X2B



	BL33X2B	FREE
Type	2 Bowls	<ul style="list-style-type: none"> • Drainer 3.5 " Big Basket • with overflow P-TRAP (P32PP) ★ NOT INCLUDED TAP
Overall Dimension	75 x 47 cm. Thick 0.8 mm..	
Bowl size	33 x 41 cm. Depth 19 cm.	
Cutting size	71 x 43 cm. (Radial 95 mm.)	

BSC55



BSC45



BSC40



	BSC55	BSC45	BSC40	FREE
Type	1 Bowl	1 Bowl	1 Bowl	<ul style="list-style-type: none"> • Drainer 3.5 " Big Basket • with overflow P-TRAP (P32PP) ★ NOT INCLUDED TAP
Overall Dimension	59 x 44 cm. Thick 1.0 mm	49 x 44 cm. Thick 1.0 mm.	44 x 44 cm. Thick 1.0 mm.	
Bowl size	55 x 40 cm. Depth 20 cm.	45 x 40 cm. Depth 20 cm.	40 x 40 cm. Depth 20 cm.	
Cutting Size	55 x 40 cm.	45 x 40 cm.	40 x 40 cm.	

BLC38

BLC32

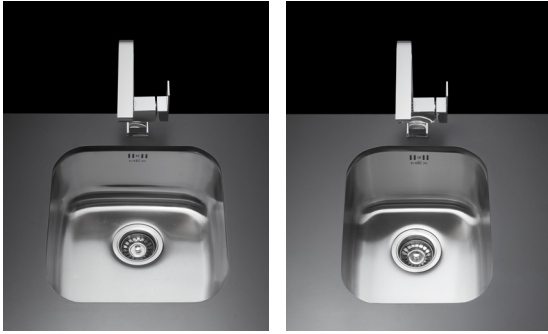

	BLC38	BLC32
Type	1 Bowl	1 Bowl
Thickness	0.8 mm.	0.7 mm.
Bowl Size	• 38 x 40 cm. Depth 20 cm.	32 x 38 cm. Depth 20 cm.
Cutting-Size	38 x 40 cm.	32 x 38 cm.

FREE

- Drainer 3.5" Big Basket
- P-TRAP (P11PP)
- * NOT INCLUDED TAP**

MU47B

BL41B

BL33B



	MU47B	BL41B	BL33B
Type	1 Bowl	1 Bowl	1 Bowl
Overall Dimension	50 x 43 cm. Thick 0.8 mm.	43.6 x 43.6 cm. Thick 0.8 mm.	35.8 x 43.8 cm. Thick 0.8 mm.
Bowl Size	47 x 40.2 cm. Depth 18 cm.	41 x 41 cm. Depth 22.3 cm.	33 x 41 cm. Depth 19 cm.
Cutting Size	46.5 x 39.5 cm.	40.5 x 40.5 cm.	32.5 x 40.5 cm.

FREE

- Drainer 3.5" Big Basket
- Overflow P-TRAP (P11PP)
- * NOT INCLUDED TAP**

ST Series
THICKER IS BETTER



ST821 : Sink with Accessories

Sink AISI304 with thicker rim 4 mm and upgraded with Modern Design to be applicable with various functions from addition accessories

- 1 Bowl
- Overall Dimension 82 x 53 cm. Edge Thickness 4 mm.
- Bowl Size 77 x 40 cm. Depth 22.5 cm.
- Bowl thickness 1.2 mm.
- Cutting Size 80 x 51 cm.

FREE

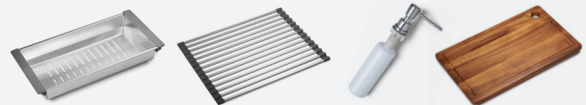

- Colander CL23
- Roll mat RM330
- Soap Dispenser SD03
- Wooden Cut Board CB260
- NOT INCLUDED TAP
- Drainer 3.5" Big Basket
- Overflow with P-TRAP (P31PP)

TD Series
**EVERYDAY
 FUNCTIONAL SINK**



AISI 304 series stainless steel sinks with functional accessories. From MEX mindfully designed kitchen sink and its workstation to meet the modern lifestyle for a limited kitchen space.



TD822

- 2 Bowls
- Overall Dimension 82 x 48 cm. Thick 1.0 mm.
- Bowl Size 43.5 x 40 cm. 29 x 34 cm. Depth 21 cm.
- Drainer 3.5 " Big Basket
- Overflow with P-TRAP (P36PP)
- Cutting Size 80 x 46 cm.

FREE



Drain Basket Stainless Steel
 BKT330



Cut Board
 CB310



Soap Dispenser
 SD03

#NOT INCLUDED
 TAP



TD76

- 1 Bowl
- Overall Dimension 76 x 48 cm. Thick 1.0 mm.
- Bowl Size 63 x 40 cm. Depth 21 cm.
- Drainer 3.5 Big Basket
- Overflow with P-TRAP (P31PP)
- Cutting Size 74 x 46 cm.

FREE



Drain Basket Stainless Steel
 BKT3300



Cut Board
 CB260



Soap
 Dispenser
 SD03

#NOT INCLUDED
 TAP



SUMO Series

Uniqueness of the Sumo Series
A big deep bowl with a tap in the center to support large containers which is suitable for Modern Thai Style kitchen

SUMO Series

Big bowl kitchen Sink

SUMO3BL SET



SUMO3 SET



	SUMO3BL SET	SUMO3 SET
Type	1 Bowl 1 Drain	1 Bowl
Overall Dimension	116 x 50 cm. Thick 0.8 mm.	80 x 50 cm. Thick 0.8 mm.
Bowl Size	71.2x41.2 cm. Depth 25 cm.	71.2x 41.2 cm. Depth 25 cm.
Cutting Size	114 x 48 cm.	78 x 48 cm.

FREE



- Stainless Steel basket
- Cut Board
- Drainer 3.5" Big Basket
- Overflow with P-TRAP (P31PP)
- * **NOT INCLUDED TAP**

SUMO3BL



SUMO3



	SUMO3BL	SUMO3
Type	1 Bowl 1 Drain	1 Bowl
Overall Dimension	116 x 50 cm. Thick 0.8 mm.	80 x 50 cm. Thick 0.8 mm.
Bowl Size	71.2 x 41.2 cm. Depth 25 cm	71.2 x 41.5 cm. Depth 25 cm.
Cutting Size	114 x 48 cm	78 x 48 cm.

FREE

- Drainer 3.5" Big Basket
- Overflow with P-TRAP (P31PP)
- * **NOT INCLUDED TAP**

DLS Series**Best Seller Stainless Steel Sink Series DLS****DLS200B****DLS86B**

	DLS200B	DLS86B	FREE
Type	2 Bowl 1 Drain	2 Bowls	<ul style="list-style-type: none"> • Drainer 3.5" Big Basket • Overflow with P-TRAP (P35PP) <p>* NOT INCLUDED TAP</p>
Overall Dimension	120 x 50 cm. Thick 0.7 mm	86 x 50 cm. Thick 0.7 mm.	
Bowl Size	41.5 x 39.5 cm. Depth 20 cm. 33 x 39.5 cm. Depth 18 cm.	41.5 x 39.5 cm. Depth 20 cm. 33 x 39.5 cm. Depth 18 cm.	
Cutting Size	118 x 48 CM.	84 x 48 CM.	
Installation	Installed both left or right hand		

DLS100B**DLS860B****DLS80B**

	DLS100B	DLS860B	DLS80B	FREE
Type	1 Bowl 1 Drain	1 Bowl 1 Drain	1 Bowl 1 Drain	<ul style="list-style-type: none"> • Drainer 3.5" Big Basket • Overflow with P-TRAP (P31PP) <p>* NOT INCLUDED TAP</p>
Overall Dimension	100 x 50 cm. Thick 0.6 mm.	86 x 50 cm. Thick 0.6 mm	82 x 47 cm. Thick 0.6 mm.	
Bowl Size	48 x 41.5 cm. Depth 20.5 cm.	41.5 x 39.5 cm. Depth 20.5 cm.	41.5 x 39.5 cm. Depth 20.5 cm.	
Cutting Size	98 x 48 cm.	84 x 48 cm.	80 x 45 cm.	
Installation	Installed both left or right hand	Installed both left or right hand	Installed both left or right hand	

DLS60B**DLS50B**

	DLS60B	DLS50B	FREE
Type	1 Bowl 1 Drain	1 Bowl	<ul style="list-style-type: none"> • Drainer 3.5" Big Basket • Overflow with P-TRAP (P31PP) <p>* NOT INCLUDED TAP</p>
Overall Dimension	63 x 47 cm. Thick 0.6 mm.	50 x 50 cm. Thick 0.6 mm..	
Bowl Size	33 x 39.5 cm. Depth 20.5 cm.	41.5 x 39.5 cm. Depth 20.5 cm	
Cutting size	61 x 45 cm.	48 x 48 cm.	
Installation	Installed both left or right hand		

BIX Series **Stainless Steel Sink**

BIX3-LB | BIX3-RB



	BIX3-LB (Left Bowl Right Drain) BIX3-RB (Right Bowl Left Drain)	FREE
Type	2 Bowls 1 Drain	<ul style="list-style-type: none"> • Drainer 3.5" Big Basket • Overflow with P-TRAP(P32PP) <p>* NOT INCLUDED TAP</p>
Overall Dimension	120 x 50 cm. Thick 0.8 mm.	
Bowl Size	41 x 41 cm. Depth 24 cm. 33 x 41 cm. Depth 20.5 cm.	
Cutting Size	118 x 48 cm.	

BIX1B



	BIX1B	FREE
Type	1 Bowl 1 Drain	<ul style="list-style-type: none"> • Drainer 3.5" Big Basket • Overflow with P-TRAP (P31PP) <p>* NOT INCLUDED TAP</p>
Overall Dimension	86 x 50 cm. Thick 0.8 mm.	
Bowl Size	45 x 40 cm. Depth 22 cm.	
Cutting Size	84 x 48 cm.	
Installation	Installed both left or right	



	TWIN-B	FREE
Type	2 Bowls	<ul style="list-style-type: none"> • Drainer 3.5" Big Basket • Overflow with P-TRAP (P32PP) <p>* NOT INCLUDED TAP</p>
Dimension	91 x 50 cm. Thick 0.8 mm..	
Bowl Size	41 x 41 cm. Depth 22.3 cm	
Cutting Size	89 x 48 cm.	

MSA200B



	MSA200B	FREE
Type	2 Bowls 1 Drain	<ul style="list-style-type: none"> • Drainer 3.5" Big Basket • Overflow with P-TRAP (P32PP) <p>* NOT INCLUDED TAP</p>
Overall Dimension	120 x 50 cm. Thick 0.6 mm.	
Bowl Size	41 x 41 & 33 x 41cm.Depth18.5 cm	
Cutting Size	118 x 48cm.	
Installation	Installed both left or right	

DL75MN



	DL75MN	FREE
Type	1 Bowl 1 Drain	<ul style="list-style-type: none"> • Drainer 4" MN • Overflow with P-TRAP (P41PP) <p>* NOT INCLUDED TAP</p>
Overall Dimension	75 x 43 cm. Thick 0.5 mm.	
Bowl Size	40.5 x 36.5 cm. Depth 16 cm.	
Cutting Size	73 x 41 cm.	
Installation	Installed both left or right	

DLA Series Super Value Serie Sink

DLA202



	DLA202	FREE
Type	2 Bowls 1 Drain	<ul style="list-style-type: none"> • Drainer 4" MN • Overflow with P-TRAP (P42PP) <p>★ NOT INCLUDED TAP</p>
Dimension	120 x 50 cm. Thick 0.6 mm.	
Bowl Size	37.2 x 40 cm. Depth 16 cm	
Cutting Size	118 x 48 cm.	
Installation	Installed both left or right hand	

DLA101



DLA81



DLA50



	DLA101	DLA81	DLA50	FREE
Type	1 Bowl 1 Drain	1 Bowl 1 Drain	1 Bowl	<ul style="list-style-type: none"> • Drainer 4" MN • Overflow with P-TRAP (P41PP) <p>★ NOT INCLUDED TAP</p>
Dimension	100 x 50 cm. Thick 0.6 mm	80 x 50 cm. Thick 0.6 mm.	50 x 50 cm. Thick 0.6 mm.	
Bowl Size	40 x 41 cm. Depth 19 cm.	37.2 x 40 cm. Depth 17.5 cm.	40.5 x 36.5 cm. Depth 19 cm.	
Cutting Size	98 x 48 cm.	78 x 48 cm.	48 x 48 cm.	
Installation	Installed both left or right hand	Installed both left or right hand		

Small Space Sink Stainless Sink for small kitchen space

R5B



D60B



	R5B	D60B	FREE
Type	1 Bowl Round	1 Bowl	<ul style="list-style-type: none"> • Drainer 3.5" Big Basket • Overflow with P-TRAP (P31PP) <p>★ NOT INCLUDED TAP</p>
Dimension	Ø 51 cm. Thick 0.8 mm.	64.5 x 50 cm. Thick 0.6 mm.	
Bowl Size	Ø 40 cm. Depth 18 cm..	54.5 x 40 cm. Depth 22cm.	
Cutting Size	Ø 49 cm.	60.5 x 48 cm. (Radial 30 mm.)	

R4B



ORION-B



	R4B	ORION-B	FREE
Type	Bowl Round	1 Bowl	<ul style="list-style-type: none"> • Drainer 3.5" Big Basket • Overflow with P-TRAP (P31PP) <p>★ NOT INCLUDED TAP</p>
Dimension	Ø 45 cm Thick 0.8mm.	38.2 x 46.2cm. Thick 0.8 mm.	
Bowl Size	Ø 40 cm. Depth 18cm.	33 x 41 cm. Depth 19cm	
Cutting Size	Ø 43 cm.	36.2 x 44.2 cm. Radial 95 mm	

Free Standing Sink

Stainless Free Standing Sink

**AISI
304**
**STAINLESS
STEEL
AISI 304**

PS706L

- 1 Bowl Stainless steel AISI 304, thick 0.8 mm.
- Standing Legs are Stainless steel AISI 304, thick 0.8 mm.
- Lower shelve Stainless Steel AISI 304 Thickness 0.5 mm.
- Dimension 63 x 56 x 86 cm
- Bowl size 55.5 x 48 cm..
- Depth 30.5 cm.
- Drainer 6 inches with garbage basket overflow
- flexible hose
- Adjustable Plastic base Protectors Cups
- NOT Include Tap



PSD60

- 1 Bowl Stainless steel AISI 304, thick 0.6 mm.
- Legs and Under Tray attached with barrier rails 3 sides AISI 430, Thickness 0.5 mm
- Dimension 60 X 49 x 86 cm.
- Bowl size 50.9 x 40.7 cm.
- Depth 25 cm.
- Drainer 3.5 inches with overflow and flexible hose
- Plastic base Protectors Cups cannot adjust
- NOT Include Tap



PSB55ML

- 1 Bowl Stainless steel AISI 304, thick 0.5 mm.
- Legs and Under Tray are made from AISI 201, Thickness 0.5 mm,
- Barrier rails 3 sides are made from AISI 430, thickness 0.5 mm
- Dimension 55 X 50 x 86 cm.
- Bowl size 47 x 40 cm.
- Depth 18.5 cm.
- ML Drainer 4.5 inches with garbage basket AISI304 with overflow which is removable for clean
- *MEX original patent
- flexible hose
- Adjustable Plastic base Protectors Cups
- NOT Include Tap



PSB80ML

- 1 Bowl 1Drain Stainless steel AISI 304, thick 0.5 mm.
- Legs and Under Tray are made from AISI 201, Thickness 0.5 mm,
- Barrier rails 3 sides are made from AISI 430, thickness 0.5 mm
- Dimension 80 X 50 x 86 cm.
- Bowl size 37.2 x 40 cm.
- Depth 17.5 cm.
- ML Drainer 4.5 inches with garbage basket AISI304 with overflow which is removable for clean
- *MEX original patent
- flexible hose
- Adjustable Plastic base Protectors Cups
- NOT Include Tap



PSB100ML

- 1 Bowl 1 Drain Stainless steel AISI 304, thick 0.6 mm.
- Legs and Under Tray are made from AISI 201, Thickness 0.5 mm,
- Barrier rails 3 sides are made from AISI 430, thickness 0.5 mm
- Dimension 100 X 50 x 86 cm.
- Bowl size 47 x 40 cm.
- Depth 19 cm.
- ML Drainer 4.5 inches with garbage basket AISI304 with overflow which is removable for clean
- *MEX original patent
- flexible hose
- Adjustable Plastic base Protectors Cups
- NOT Include Tap



PSB1200ML

- 2 Bowls 1 Drain Stainless steel AISI 304, thick 0.6 mm.
- Legs and Under Tray are made from AISI 201, Thickness 0.5 mm,
- Barrier rails 3 sides are made from AISI 430, thickness 0.5 mm
- Dimension 120 X 50 x 86 cm.
- Bowl size 37.2 x 40 cm.
- Depth 18 cm.
- ML Drainer 4.5 inches with garbage basket AISI304 with overflow which is removable for clean
- *MEX original patent
- flexible hose
- Adjustable Plastic base Protectors Cups
- NOT Include Tap

* Price is not included Tap

Kitchen Organizer **Stainless Shelving Unit**

SH12165 SHELVING UNIT

Multi-purpose Shelving Unit, an assistant for storage solution to tidy up equipment for comfortably using.

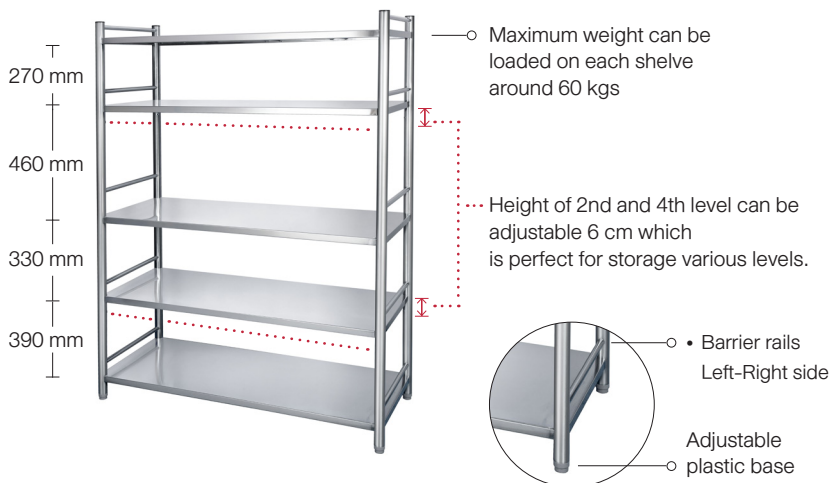

- 5 Shelves with barrier rails at both front and back side
- Top Shelf board for all 5 shelves made from stainless steel AISI 304 Thickness 0.5 mm.

- Underneath board for all 5 shelves made from stainless steel AISI 201 Thick 0.5 mm.
- Shelf legs thickness 0.8 mm.
- Dimension 120 x 50 x 165 cm.

SH1286-1 Multipurpose Work Table for Bakery Stainless Steel AISI 304

Strong Structure to support heavy weight



- Multi-purpose Stainless steel work table AISI 304
- Size 120 x 60 x 86 cm.
- Top tier 2nd and 3rd tier Thick 0.6 mm. with barrier rails 3 sides
- Table legs support Thickness 0.8 mm.
- Underneath board for all 3 shelves made AISI 201 thickness 0.4 mm.
- Adjustable plastic base cover legs
- Top Shelf can be loaded 100 kgs /2nd& 3rd Shelf can be loaded 60 kgs.

MESTER



SH8071-1

- Stainless Steel table for gas hob AISI 201 thickness 0.5 mm.
- Dimension 80 x 50 x 71 cm.
- 3 Shelves : 2nd&3rd.with barrier rails 3 sides



SH8086-1

- Removeable Clip Lock barrier on top
- Gas hose slot provided
- Maximum available loads: Top: 60 kgs. and Undershelves: 40 kgs

- Multi-purpose work table AISI 201 thick 0.5 mm.
- Size 80 x 50 x 86 cm.
- 3 Shelves :2nd&3rd.with barrier rails 3 sides
- Maximum available loads: Top: 60 kgs. and Undershelves: 40 kgs

Sink Accessories

Sink Accessories

Strainer Basket

BIG BASKET

2-STEP Function

2-STEP Function FILTER & CLOSE Put the basket into the drainer then water will rinse through the screen when push on the middle core to lock basket with drainer ,it will block up water for soaking foods, vegetable, fruit or utensils.



Innovative Newly Design Sink Drainer 3.5" with Stainless steel Big Basket to enhance filtering food scraps more effectively.

* MEX Original Patent
* Apply for some Model

ML



Big strainer 4.5" with drainer and stainless steel basket with more drainer hole to enhance performance of filtering food scraps. It can open the drain pipe to clean some dirt remaining inside
* During submitted for MEX Original Patent
* Apply for some Model

MN



Strainer 4" with drainer and stainless steel basket with more drainer hole to enhance performance of filtering food scraps. It can open the drain pipe to clean some dirt remaining inside
* MEX Original Patent
* Apply for specific Model

Drainer 3.5 Inches



Drainer Cover A275



Drainer Cover made from plastic coated by stainless steel AISI304, radius 4.5 cm, thickness 3.5 mm. with rubber ring to prevent leakage and lower twist cover made from premium quality plastic.

Sink Accessories

CB

Wooden chopping board made from Rain Tree and underwent process of phytosanitary, Food Grade, no any chemical on board, easily clean



BKT330

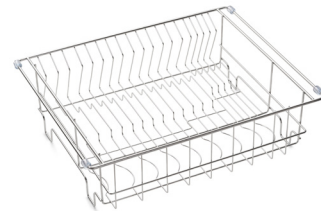

Stainless Steel Basket AISI304 with rubber plate 4 pcs size 330 x 425 x 130 mm

* fit with Sink Mode TD, SC and BSC Series or individual free stand

CB217 Size 217 x 428 x 22 mm.

*fit with Sink Mode SC and BSC Series

CB260 Size 260 x 426 x 22 mm.

* fit with Sink Mode TD76, ST821, SC and BSC Series

CB310 Size 310 x 364 x 22 mm.

* fit with Sink Mode TD822

Soap Dispenser SD03



Removeable Tap hole made from Stainless steel

CL23



Stainless steel AISI 304 Colander Tray Size 209 x 418 x 70 mm. with anti-slip plastic U

* fit to TD76, TD822, SC and BSC Series

RM330



Roll Mat size 330 x 426 mm. made from Stainless steel AISI 304 with anti-slip

* fit with some Model

SUMO Chopping Board



Wooden chopping board made from Eucalyptus- To fit with model SUMO3 and SUMO3BL size 48.7 x 22.0 x 2.3 cm.

SUMO Basket



Stainless Steel Basket to fit with sink model SUMO3 and SUMO3BL size 44.7 x 23.0 x 16.3 cm.

SUMO Colander

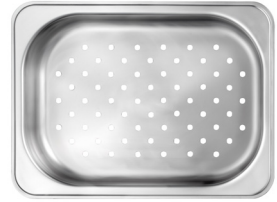

Stainless Steel AISI 304 colander size 32.7 x 44.1 x 8.5 cm.

P-trap Drain Pipe [P TRAP]

P41PP

Fit with Drainer 4" MN and 4.5"ML

Drain Pipe for Single bowl Easy fit, enable to connect to the wall and floor

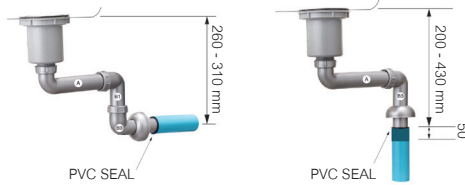

P51PP

Drain Pipe for Single bowl Easy fit, enable to connect to the wall and floor

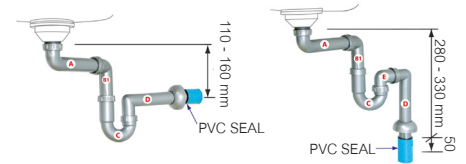

Normal

Normal

P42PP

Fit with Drainer 4" MN and 4.5"ML

Drain Pipe for Double bowl Easy fit, enable to connect to the wall and floor

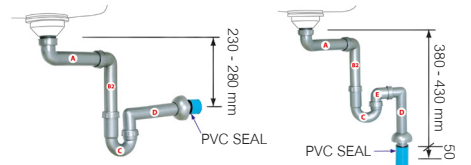
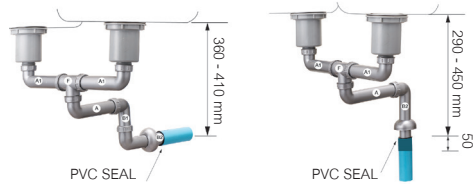

Extra Low

Extra Low

P31PP

Drain Pipe for Single bowl Easy fit, enable to connect to the wall and floor

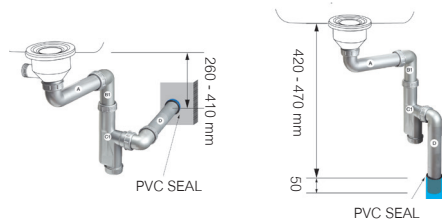

P52PP

Drain Pipe for Double bowl Easy fit, enable to connect to the wall and floor

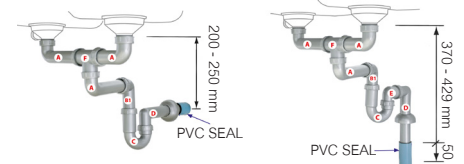

Normal

Normal

P32PP

Drain Pipe for Double bowl Easy fit, enable to connect to the wall and floor

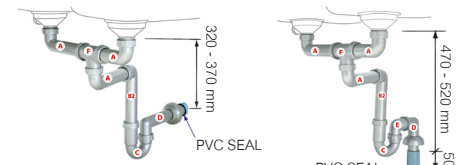
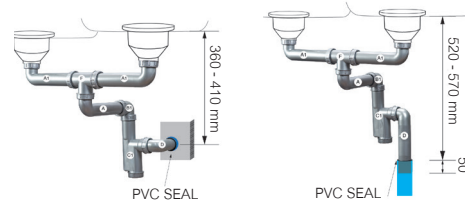

Extra Low

Extra Low



07

| Tap

When design meets function

At the Heart of Kitchen Elegant Design

One Way Mixer



C  H



Stand out with style in a modern kitchen space. With the idea swivel tubular C-spout with mousseur, coating by matted black faucet body contrasting with handle wipe in a copper tone. Unique to control the on-off water and temperature with a single valve. Perfectly reflects the identity of the user.

1905S-F166B

- Matted Black body
- Ceramic disc cartridge
- Aerator which percolate water gently
- Handle Wiper coating Copper color
- Projection 180 mm.
- Tap hole Ø 32 mm.

 H **387 mm**

Design to Difference Why we should be like anyone?

Modern Design Faucet to reflect the user unique style with Red Handle wiper

2105S-E40BR

- Matted Black
- Ceramic disc cartridge
- Aerator which percolate water gently
- Handle Wiper Red Color
- Projection 200 mm.
- Tap hole Ø 32 mm



 H **381 mm**



New design valve

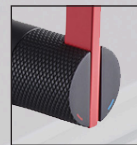

Swap Valve Adjust Cool to hot

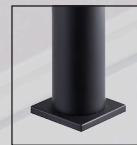

Square Tap Base



Unique design rough surface

The Essence of Grey

Gray faucet with a unique shade slim swivel tubular C-spout with mousseur, Compatible with various style sink designs.

1105-E35G

- Gray Color
- Ceramic disc cartridge
- Aerator which percolate water gently
- Handle Wiper
- Projection 210 mm.
- Tap hole Ø 32 mm



 H **412 mm**

Sleek in Detail

Matted Black faucet with chrome handle wiper fit to perfect faucet height.

11105SB-E36B

- Matted Black
- Ceramic disc cartridge
- Aerator which percolate water gently
- Handle Wiper
- Projection 210 mm.
- Tap hole Ø 32 mm



 H **397.2 mm**

Symbol guideline:

 Hot&Cold mixed Tap  Cold Tap





 Rotating 360

 **000 mm** Height

Innovation with Style

The best design hot-cold water mixer faucet.
Innovation beyond words

2-Way Spout

- 1  Percolates water gently
- 2  Spray Head
-  Flexible Spray hose
-  Swivel area 360 degree
-  Magnetic docking system to lock spray head into place

11088QT-D94A ● ●

- Brass body, Stainless steel Spout coating chromium-black
- Ceramic disc cartridge
- Removable spout with flexible direction
- Aerator which percolate water gently
- Handle Wiper
- Projection 232 mm.
- Tap hole Ø 35 mm
- Top Counter Fitting



More details and review on website

 H 615 mm



When Design Meets Function



9328-D6 ● ●

- Chromium
- Ceramic disc cartridge
- Spring Spout
- Handle Wiper
- Removable and flexible spray
- Tap hole Ø 35 mm.

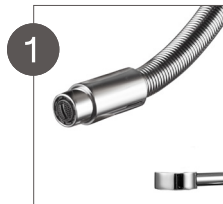

Adjustable Pull-out Spray

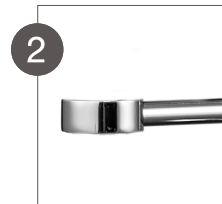

Fitting Ring lock spray head

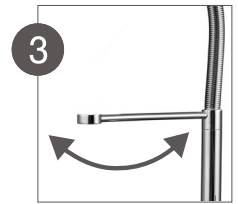

The center axis can be rotated 360 degree



More details and review on website

 H 495 mm

A New Perspective Design

Hot-Cold and Drinking water mix faucet

Duo Flow

Make you life easier with Hot & Cold and Drink water mixed faucet : 3 in 1 to save more space

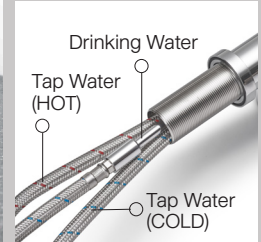
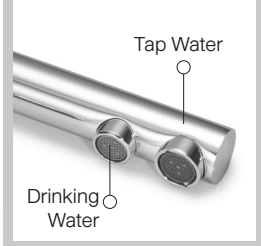
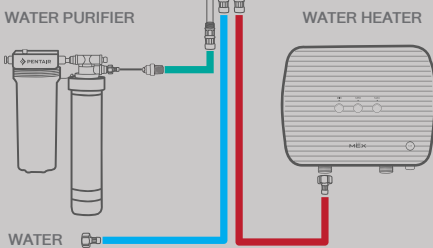

1355-D6 ●●

- Brass body coating chromium color
- Ceramic disc cartridge
- Aerator which percolate water gently
- Handle Wiper
- Projection 206 mm.
- Tap hole Ø 32 mm

360° H 295 mm

Stylish Functionality



9318-D6 ●●

- Chromium color
- Ceramic disc cartridge
- Handle Wiper
- Removable pull-out adjustable spray
- Tap hole Ø 35 mm.



1 Press Button to pull-out spray

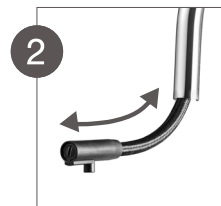

2 Flexible pull-out and conceal spray head

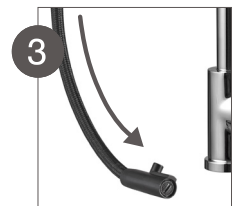

3 Longer hose length



More details and review on website

360° H 436 mm



Kitchen Sink Mixer Tap

Countertop Kitchen Sink Mixer Tap



1345-D6



- Chromium
- Ceramic disc cartridge
- Handle Wiper

360° H 291 mm

1345-D6 (B)



- Black
- Ceramic disc cartridge
- Handle Wiper

360° H 291 mm

More details and review on website



1345-D6 (W)



- White
- Ceramic disc cartridge
- Handle Wiper

360° H 291 mm

TP2141M



- Chromium
- Ceramic disc cartridge
- Handle Wiper

360° H 297 mm

11105SB-E36



- Brass body, Stainless steel Spout
- Chromium
- Ceramic disc cartridge
- Aerator which percolate water gently
- Handle Wiper
- Projection 189 mm.
- Tap hole at least Ø 32 mm.

360° H 380.2 mm

11105S-E36



- Brass body
- Stainless steel Spout
- Chromium
- Ceramic disc cartridge
- Aerator which percolate water gently
- Handle Wiper
- Projection 210 mm.
- Tap hole at least Ø 32 mm

360° H 397.2 mm

11005S-E9



- Chromium
- Ceramic disc cartridge
- Handle Wiper

360° H 399 mm

Kitchen Sink Cold Water Tap

Counter Top Kitchen Cold Tap

1105KSD-E9B



- Black
- Ceramic disc cartridge
- Swivel Spout 360
- Aerator which percolate water gently
- Handle Wiper
- Projection 217 mm.

360° H 351 mm

1105KSD-E9



- Chromium
- Ceramic disc cartridge
- Swivel Spout 360
- Aerator which percolate water gently
- Handle Wiper
- Projection 217 mm.

360° H 351 mm

1105KSB-E9B



- Black
- Ceramic disc cartridge
- Swivel Spout 360
- Aerator which percolate water gently
- Handle Wiper
- Projection 189 mm.
- Tap hole at least 32 mm.

360° H 381 mm

1105KSB-E9



- Chromium
- Ceramic disc cartridge
- Swivel Spout 360
- Aerator which percolate water gently
- Handle Wiper
- Projection 189 mm.
- Tap hole at least 32 mm.

360° H 381.5 mm

TP1030

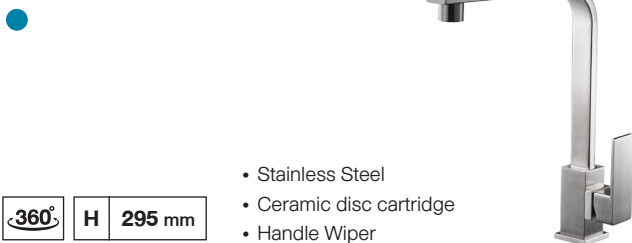

- Stainless Steel
- Ceramic disc cartridge
- Handle Wiper

360° H 295 mm

TP1142

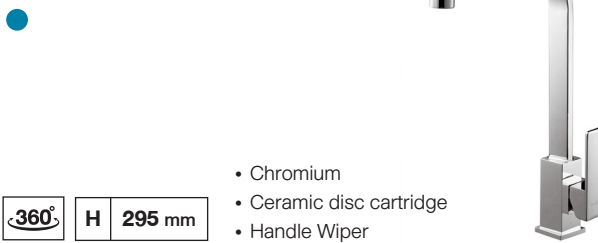

- Chromium
- Ceramic disc cartridge
- Handle Wiper

360° H 295 mm

120B-F25



- Chromium
- Ceramic disc cartridge
- Handle Wiper

360° H 278 mm

N262IX



- Stainless Steel
- Ceramic disc cartridge
- Handle Wiper

360° H 295 mm

N261IX



- Chromium
- Ceramic disc cartridge
- Handle Wiper

360° H 295 mm

TP227



- Chromium
- Ceramic disc cartridge
- Handle Wiper

360° H 288.5 mm

EASY-FIT

The Easiest innovative installation of faucet just in 5 minutes



Aerator which percolates water gently



Material stainless steel AISI304, high spout, flexible swivel 360 degree with handle wiper



EASY-FIT Original Patent for super easy 5 min installation from above countertop, not be complicate like undercounter



Extra long hose 500 mm. including the hex nut block cover used to screw hex nut.

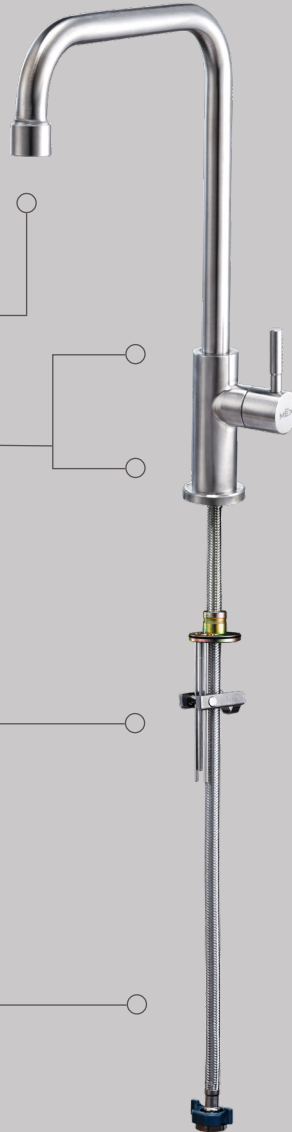

4

How to install EASY-FIT



1 Lean Tap along the side and pass flexible hose through the hole in the sink



2 Lock up base tightly by screwdriver or electric drill



3 Settle Tap body straight angle and tighten up by the L-shape Hex Key

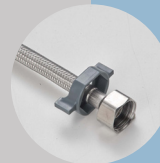

4 Connect Hose to the valve and tighten up the joint by screw hex nut.

E301IX



- Stainless Steel
- Ceramic disc cartridge
- Aerator which percolate water gently
- Handle Wiper
- Projection 190 mm.
- Tap hole at least \varnothing 32 mm.

360° H **340 mm**

E302IX



- Stainless Steel
- Ceramic disc cartridge
- Aerator which percolate water gently
- Handle Wiper
- Projection 205 mm.
- Tap hole at least \varnothing 32 mm.

360° H **320 mm**



08

| Small Appliance

Enjoy Healthy Life

MIDI OVEN

Free Stand Oven

New minimal design with all in one cooking and bakery function to create various new recipe perfectly



EASY TOUCH & EASY CONTROL

Digital Timer

Pop-up Design

BIG SATISFACTION

45L Capacity

Designed with 3 racks, large cavity for cooking with hot fan assist for your perfectly cook



Compact Table Top Electric Oven MIDI456ES



- Tabletop electric oven 45 Liters
- Material: Black mirror / CREAM Design
- Nominal Power: 1400W
- 5 cooking functions with yogurt making functions
 - > Top heater coil program
 - > Bottom heater coil program
 - > Top and Bottom heater coil program
 - > Top and Bottom heater coil with a fan program
 - > Bottom heater coil with a fan program
- Temperature ranges up to 40-240 degrees Celsius
- Digital Screen Timer setting for a maximum of 4 hours
- Rotary Round Pop-up Knob control
- High quality double-glazed glass design safe to use high heat resistance
- The fan works to distribute the heat
- inside with interior lighting Automatic light while operating
- There is tray cover the heating element below to protect you from harmful and easy-to-clean
- 3 rack oven's large size for more versatile use
- Stream Cleaning function makes cleaning up easier
- Durable door with two sides brackets and classy design door holder
- Accessories :Enamelled tray X 1, Baking tray X 1
- Made in Europe

STEAM TOASTER OVEN

The right toaster makes your kitchen feel warm.

Technology for baking bread together with heating and steaming creating a different taste, crispy on the outside, soft on the inside "Ready for you to enjoy breakfast perfectly"



YURI

Great taste in everyday cooking.

STEAM TOASTER OVEN YURI101SC

- Steam Toaster Oven / Cream Color
- 10 Liters
- 2 layers glass windows
- Outside normal glass; inside Low E glass to reduce heat exhaust or energy saving
- Nominal Power 1,300 W
- Product Dimension 35.3 x 31.8 x 22.6 cm.
- N.W. 5.2 Kgs
- 7 Presets Cooking Programs
- Temperature control 100-230degrees
- DIY mode included maximum time: 30 minutes
- Warning bell system after the end of operation
- Glass are easy to see inside
- On/ Off touch screen operating system
- START touch screen operating system
- PAUSE touch screen operating system
- Two knobs control programs, time, and temperature
- Digital display shows programs, time, and temperature

ACCESSORIES:

- Baking tray X1
- Rack X1
- 5cc water tank X1
- Galvanized crumbs tray X1



P1: Bread
2-3 min



P2: Toast
3-5 min



P3: Croisan
2.5-3.5 min



P4: Pizza
10-13 min



P5: Cubcake
12-16 min



P6: Cookies
15-20 min



P7: Wing
15-18 min



ARI | Air Fryer 3 Liters

- Non-Stick Frying Basket
- Accessories: 1x Frying Basket, 1x Cooking Tray and 1x Water Cub
- Light Indicator
- Dimension WxDxH
- : 24.9 x 30.8 x 30.5 cm
- Input Power 1,300W
- Body Cream Color Capacity 3.0 L
- Cooking Temperature Knob max. 200 C
- Cooking Timer Knob max. 60 min
- Rapid Air Heating Technology
- Extra Accessories: Stainless Steel AISI304 water cub
- Automatic power off
- Handle made from plastic cool touch

KPLG105TW-1 | Electric Kettle 0.5 Liter

Double layer kettle, SS304 inner body, plastic housing and wooden bakelite Cordless electric kettle: separate base 360. rotation base design. With Filter SS304 Made of high-grade stainless steel, Cool touch and Anti scald protection with double layer structure, speed heating within 3-8 min

*Depending on Water Volume

- Technical Information
- Input power: 420-500W
- Voltage/ Frequency : 220 - 240V,50-60Hz
- Overall Dimension : 14.7 x 9.8 x 22 CM.



0.5 L

Tea Filter
S/S Grade AISI 304
Made of high-grade stainless steel



Special Function! Digital Display Showing real time Boiling temperature 6 levels to select a proper temperature for your favourite drink

Milk Powder 40°C	Warm Water 55°C	Oolong 70°C
Green Tea 85°C	Hot Coffee 95°C	Boiled Water 100°C



More details and review on website

KATE | Electric Kettle 1.0 Liter

- Minimal Style
- 360 Degree Rotation base design
- Automatic power will be off when the water reaches boiling point and its level is dry.
- LED blue light on/off control
- Cordless electric kettle, a separated base is conveniently movable.
- Concealed heating element, safety and easy cleaning.
- Double layers kettles : Inner High Grade Stainless Steel AISI304 & Outer Plastic Housing cool touch.
- Strix Thermostat
- Input Power : 800-950W
- Votage : 220 - 240V, 50-60Hz
- Dimention WxDxH : 19 x 13.8 x 22cm.



● KPL110B - BLACK



○ KPL110W - WHITE



More details and review on website

VACIO



09

Cordless Vacuum Cleaner

Make your best life



Cordless Vacuum Cleaner VACUUM MEX VACIO



VM601

- Cordless Vacuum with roller suction head & handle
- Designed to be able to stand by its own
- Powered by a new Lithium-ion battery, 28.8 Volts
- With BLDC digital motor spins at up to 100,000rpm
- Section Power: 22 KPa/ 150 AW
- Suction Levels: 3 levels
- Normal Brush MAX/MIN) Up to 65 min / ≥10 min
- Charge time 4-5 hours
- Easily to charge by a Stand Battery Charger
- Cyclone Technology 4 level filters
- Powerful Moterized Brush

Technical Information

- Dust Capacity: 0.45L
- Net Weight 3.5 Kg.
- Overall Dimension: W255 x H1130 x D215 mm.

ACCESSORIES

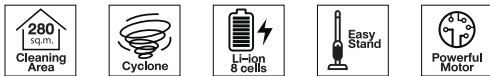
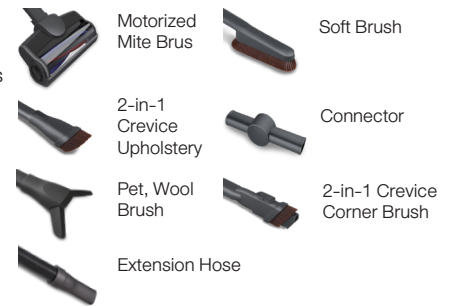

VS505

Cordless Vacuum with roller suction head & handle

- 2-in-1 Design for vacuum and wipe cleaning
- 90-degree angle bended tube
- Powered by Lithium-ion battery, 21.6 Volts
- With BLDC digital motor spins at up to 100,000rpm
- Section Power: 17 KPa/ 120 AW
- Suction Levels: 2 levels
- Normal Brush (MAX/MIN) Up to 40 min / ≥10 min
- Charge time 4-5 hours *
- Removable Battery, Easy for charging
- 180-degree Rotation Motor Head
- Powerful Moterized Brush

Technical Information

- Dust Capacity: 0.4 L
- Net Weight 3. Kg.
- Overall Dimension: W260 x H1180 x D235 mm

ACCESSORIES



* When operate with normal brush not motor brush

** Charging time depends on usage conditions and battery life spun.

Purifina



10

| Air Purifier

Fresh Air For Life

UV-C TECHNOLOGY

Air disinfection by UV-C Lights, effective against virus & bacteria.

Experience the better assure of cleanliness with New MEX Air Purifier. UV-C technology that increases the efficiency of disinfection and inhibits bacteria and fungi on the filter.

MEX
Purifina

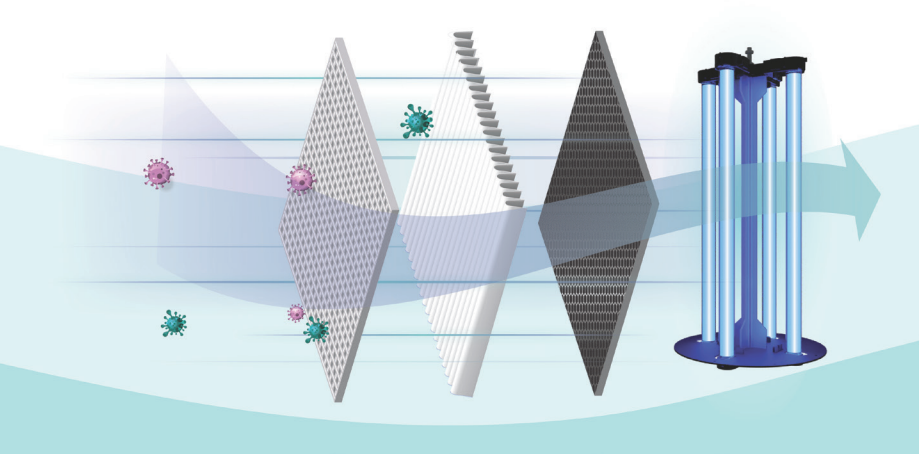

P402-UV

CADR 420 (m³/h)
Room Size 35-60 SQ.M.



P302-UV

CADR 220 (m³/h)
Room Size 20-30 SQ.M.

Air purifier and Air disinfection

- Enhance Bacteria & Fungi disinfection of the air filter with UV-C lamp which does not generate Ozone.
- 3 layers of filters to filtrate 99.97% of small particle 0.3 micron.
- User Friendly design for easy usage.
- PM2.5 indicator real time Display
- The replace filter and UV-C lamp indicator.
- 3 Fan Speed Setting
- Digital Timer Relay max 16 hours
- Rated Power 50W (DC)
- Noise Level: ≤ 60 dB(A)
- UV-C lamp lasts 9,000 hours Pollution / Clean

Pollution Clean



HEPA H12 (*Only for filters not include UV-C)



Air Filter FHC-P402



Air Filter FHC-P302

Air Purifier MEX Purifina

P501

- Enhancing the air clearing efficiency to covers room area up to 50-70 Sqm
- Ionizer Function Enhance the ability of ions attack small particles
- High efficiency filter can capture 99.95% of harmful particles from the air
- Child Lock
- AQI Light 4 Colors warning PM 2.5
- The replace filter indicator
- 3 Fan Speed Setting
- Rated Power 70W (DC)
- Noise Level: ≤ 61 dB(A)



P401

- AQI Light 4 Colors to determine the air quality. (PM 2.5)Real Time
- Child Lock
- The replace filter indicator to remind replace new filter
- 4 Fan Speed Setting
- Rated Power 30W (DC)
- Noise Level: ≤ 63 dB(A)



CADR 580 (m³/h) **Room Size** 50-70 SQ.M.

Pollution Clean

CADR 400 (m³/h) **Room Size** 28-48 SQ.M.

Pollution Clean



Filter for P501 HEPA H13
FHC-P501 ★★★★★



Filter for P401 HEPA H13
FHC-P401 ★★★★★

P301

- Innovative and powerful design
- High efficiency filter can capture 99.95% of harmful particles from the air by HEPA13
- Smart Sensor technology instant and accurate indoor air quality readings real time.
- The replace filter indicator
- 3 Fan Speed Setting
- Rated Power 27W (DC) • Noise Level: ≤ 61 dB(A)



P201

- Design in a compact size with a fully functions make it easy to fit in any area.
- Ionizer Function Enhance the ability to keep air fresh by using ions attack small particles
- The replace filter indicator
- 2 Fan Speed Setting
- Rated Power 40W
- Noise Level: ≤ 61 dB(A)



CADR 200 (m³/h) **Room Size** 17-30 SQ.M.

Pollution Clean

CADR 187 (m³/h) **Room Size** 24 SQ.M.

Pollution Clean



Filter for P301 HEPA H13
FHC-P301 ★★★★★

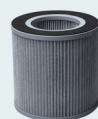

Filter for P201 HEPA H12
FHC-P201 ★★★★★

- Air Quality Sensor
- Touch Screen
- 3-STAGE Filter Pre-Filter > HEPA > Carbon
- Sleep Mode
- Timer
- Filter Replacement
- Ionizer ระบบปล่อยประจุไอออนเพิ่ม
- Child Lock
- Air Quality Light



11

Storage Water Heater

Innovation has a name.

More than 147 years experience of the Water Heater World leader A.O. Smith U.S.A

How speciality of A.O. Smith



01

Blue Diamond® Glass Lining

Last long

10+ YEARS



Blue diamond glass lining tank, is fused inside the tank to protect corrosion resistance and prolong the water heater with the long life usage to 10 years, this is innovation right reserved of A.O Smith

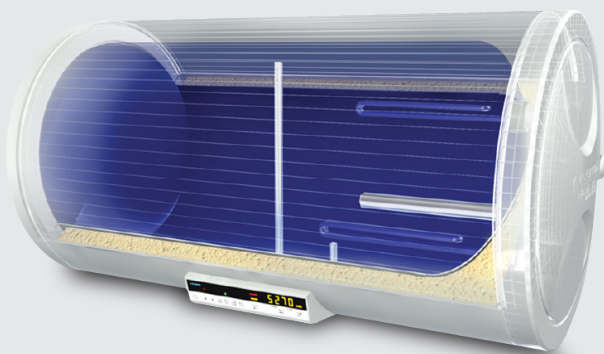

Steel

Blue Diamond® Glass Lining



Sample photo showing inside tank without Blue Diamond Glass Lining which has life usage around 3-5 years.

02



PU foam insulation to protect heat losses for 6 hours by innovative Poly Eurothyne foam of A.O. Smith



03



Double heating Element enhance heating speed fast but will not double power load to save electricity charge.

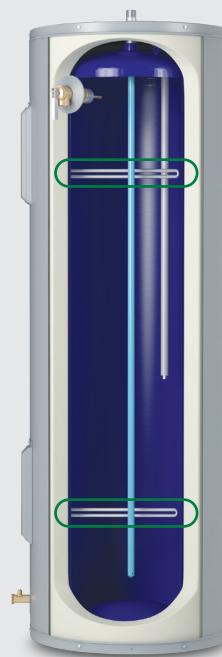

(Only for Tank Capacity 150 Ltr.)

04



Anode Rod, makes the tank durable and resistance to corrosion from hard water to prolong life span of product

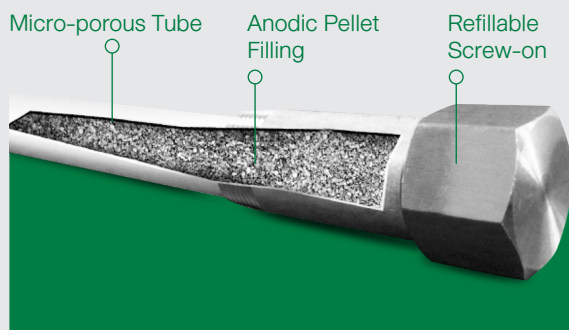

05



THERMO CUT-OUT

Thermo Cut-Out will shut down operation when the water temperature exceeds the highest preset level

- Model EES Max Temperature 78-80 C
- Model MEV Max Temperature 87 C
- Model ELJH Max Temperature 85-90 C



Storage Water Heater

Storage water heater



MEV Series

Electric Residential Storage water heater
Vertical installation

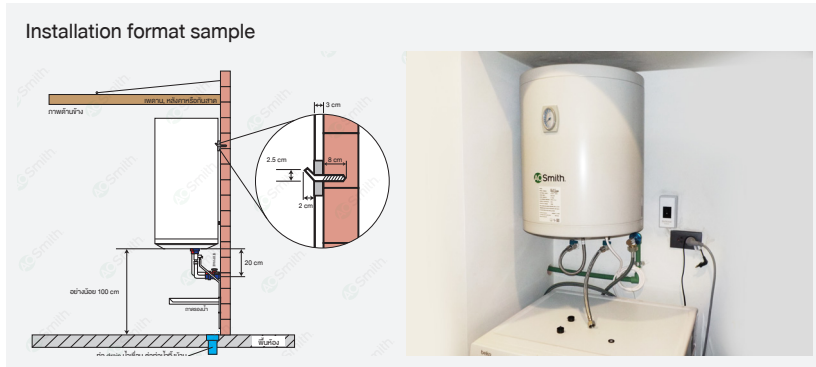

Specification	MEV-50	MEV-100
Capacity	45 Liters	90 Liters
Element power	2,000 W	2,500 W
Current Rating	220 V 50 Hz / 9.09 Amp	220 V 50 Hz / 11.36 Amp
Working Pressure	8 Bar	8 Bar
Inlet/Outlet Connection	1/2 inches (beneath)	1/2 inches (beneath)
Temperature Range	25 - 75 Celsius	25 - 75 Celsius
Dimension > Diameter (A) > Height (B)	Ø 42.5 cm 54.0 cm	Ø 42.5 cm 94.5 cm

ELJH Series

Electric Residential Storage water heater
Horizontal Installation

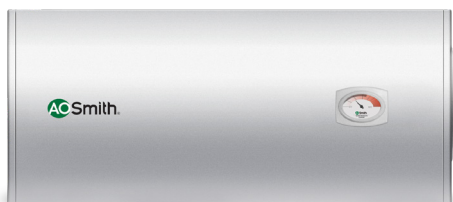

Installation format sample

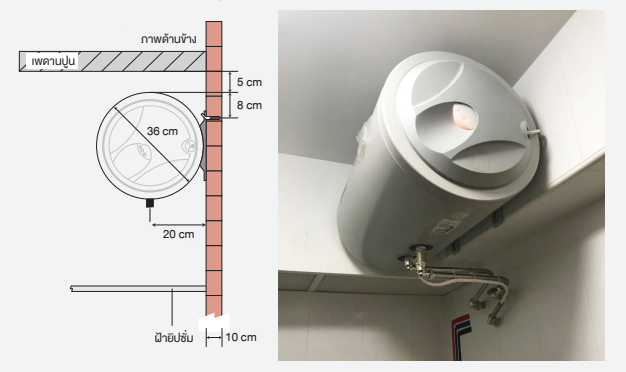

Specification	ELJH-40	ELJH-50	ELJH-80	ELJH-100
Capacity	40 Liters	50 Liters	80 Liters	100 Liters
Element power	2,000 W	2,000 W	2,000 W	2,000 W
Current Rating	220V 50 Hz / 9.09 Amp	220V 50Hz / 9.09 Amp	220V 50 Hz / 9.09 Amp	220V 50 Hz / 9.09 Amp
Working Pressure	8 Bar	8 Bar	8 Bar	8 Bar
Inlet/Outlet Connection	1/2 inches (beneath)	1/2 inches (beneath)	1/2 inches (beneath)	1/2 inches (beneath)
Temperature Range	25 - 71 Celsius	25 - 75 Celsius	25 - 75 Celsius	25 - 75 Celsius
Dimension > Diameter (A) > Length (B)	Ø 36.0 cm 60.5 cm	Ø 36.0 cm 83.5 cm	Ø 46.3 cm 86.5 cm	Ø 46.3 cm 102.5 cm



EES Series

Electric Residential
+ Light Commercial
Storage water heater
Vertical installation



Installation format sample

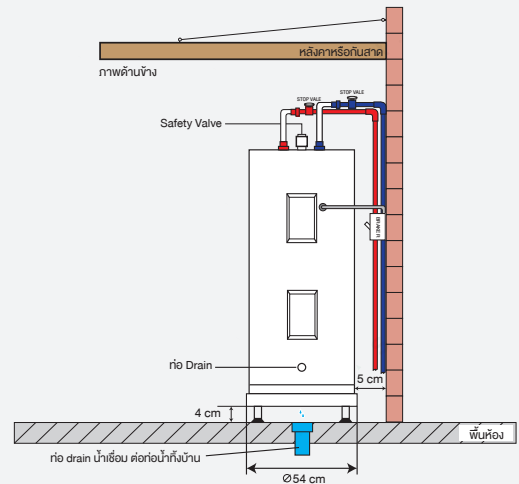

Specification	EES-40	EES-50	EES-120
Capacity	150 Liters	190 Liters	455 Liters
Element power	3,800 W	3,800 W	6,000 W
Current Rating	220 V 50 Hz / 17.27 Amp	220 V 50 Hz / 17.27 Amp	220 V 50 Hz / 27.27 Amp
Working Pressure	8 Bar	8 Bar	8 Bar
Inlet/Outlet Connection	3/4 inches (Top)	3/4 inches (Top)	3/4 inches (Top)
Temperature Range	25 - 66 Celsius	25 - 66 Celsius	25 - 66 Celsius
Dimension > Diameter (A) > Height (B)	Ø 53.0 cm 111.5 cm	Ø 53.0 cm 139.5 cm	Ø 76.0 cm 157.0 cm



MEX

12

Water Heater

Innovative & Highly Advanced
Engineering Features

MEX raises a Water Heater new standard and creates splendid, luxurious, and unique design with innovative engineering features to enhance the greater performance and high safety standard."

SAFETY SYSTEM



SAFETY THERMOSTAT

Auto shut off operating system immediately when water temperature is detected unusually high

ELCB

ELCB

Premium quality circuit breaker would detect leakage of electric just 15 milliamps and shut off the operation within 0.1 second.

IP
25

IP25

The body material of Mex water heater is made from high quality ABS which obtained safety standard IP25 to prevent water leakage into the body.

STANDARDS



TISI STANDARDS

Every model of MEX Water Heater obtained License TIS 1693-2547 from Thai Industrial Standards Institute (TISI)



TÜV SÜD

Mex Water Heater have been certified by IEC STANDARD by TÜV SÜD



ENERGY SAVING

Mex Water Heaters obtained Energy Saving Label No.5 from The Ministry of Energy of Thailand

WARRANTY



2 YEAR WARRANTY



5 YEAR WARRANTY ON HEATER TANK

THE MOST ADVANCED TECHNOLOGY FOR PERFORMANCE & SAFETY



CUBE 8000R | 8,000 W



- Nominal power : 8,000 W
- Voltage (V: 220 V 50 Hz / 36.36 Amp
- Flow rate : 3.5 Liter/min
- Water inlet pressure minimum : 0.2 bar
- Size of wire (mm2) : 3 x 6 (THW)
- Dimension : H x W x D : 29.0 x 22.0 x 9.0 c

Mex Water Heater Model CUBE has been certified International Standard by TÜV SÜD



TURBINE FLOW SENSOR

Sensor for more accuracy control to detect water flow rate to run the operation, same type that being used in to Industrial level.

CUBE 6000R | 6,000 W



- Nominal power: 6,000 W
- Voltage (V: 220 V 50 Hz / 27.27 Amp
- Flow rate : 3.5 Liter/min
- Water inlet pressure minimum : 0.2 bar
- Size of wire (mm2) : 3 x 4.0 (THW)
- Dimension : 22 X 9 X 29 cm

Mex Water Heater Model CUBE has been certified International Standard by TÜV SÜD



TURBINE FLOW SENSOR

Sensor for more accuracy control to detect water flow rate to run the operation, same type that being used in to Industrial level.

CENTRI 6R | 6,000 W



- Nominal power: 6,000 W
- Voltage V: 220 V 50 Hz / 27.27 Amp
- Flow rate : 3.5 Liter/min
- Water inlet pressure minimum : 0.2 bar
- Size of wire (mm2) : 3 x 4.0 (THW)
- Dimension : 24 X 8.5 X 19 cm

Mex Water Heater Model CENTRI has been certified International Standard by TÜV SÜD



TWIN MODULE

Design to separate electricity control system from boiler tank as independently module for safety sake



HALL EFFECT SENSOR*

For more accurate control even with the low water flow rate New Innovative by MEX



SENSOR TOUCH CONTROL

Touch control to adjust water temperature and switch on-off

MEX

Water Heater

CRYSTAL Series

Luxurious Design combine with Innovation of Digital control, adjust temperature 34 - 38°C



Mex Water Heater Model CRYSTAL has been certified International Standard by TÜV SÜD



CRYSTAL 5E (NE), (WH) | 5,100 W

- Nominal power : 5,100 W
- Voltage V: 220 V 50 Hz / 23.18 Amp
- Flow rate : 3.5 Liter/min
- Water inlet pressure minimum : 0.2 bar
- Size of wire (mm2): 3 x 4.0. (THW)
- Dimension : 20.7 X 8.7 X 36 cm

Color : ● NE Black | ○ WH white



CRYSTAL 35E (NE), (WH) | 3,500 W

- Nominal power: 3,500 W
- Voltage V: 220 V 50 Hz / 15.91 Amp
- Flow rate : 3.5 Liter/min
- Water inlet pressure minimum : 0.2 bar
- Size of wire (mm2): 3 x 2.5. (THW)
- Dimension: 20.7 X 8.7 X 36 cm

Color : ● NE Black | ○ WH white

ACCESSORIES:



- Set of Slide Bar with soap tray
- Chromium shower 5 steps
- with 2 x S/S hose U

SPECIAL FUNCTION



Upgrade Safety system with warning indication when grounding or wiring operate abnormally

HALL EFFECT SENSOR*



For more accurate control even with the low water flow rate New Innovative by MEX

ELCB TEST BAR*



MEX Original Patent Design new bottom of ELCB for easily use

CUBE Series
CUBE METALLIC BLACK

Enjoy shower with a modern classic design
Latest CUBE 6E (RMB) Metallic Black Color
match with Shower Black Metal

Mex Water Heater Model
CUBE has been certified
International Standard by
TÜV SÜD



Switch Button of normal Shower and Rain Shower

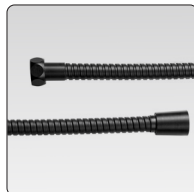

Stainless steel coating
Matt black hose x 3

CUBE 6E (RMB) | 6,000W

- Nominal power: 6,000 W
- Voltage V: 220 V 50 Hz / 27.27 Amp
- Flow rate : 3.5 Liter/min
- Water inlet pressure minimum : 0.2 bar
- Size of wire (mm2) : 3 x 4.0 (THW)
- Dimension : 22 X 9 X 29 cm

Color: ● RMB Black



With a set of Shower Black color
,5 water levels adjustment, stainless steel
hose and soap tray coating all black

CUBE 5E (MB) | 5,100W

- Nominal power: 5,100 W
- Voltage V :220 V 50 Hz / 23.18 Amp
- Flow rate : 3.5 Litre/min
- Inlet pressure minimum: 0.2 bar
- Size of wire (mm2) : 3 x 4.0 (THW)
- Dimension : 22 X 9 X 29 cm

Color: ● MB Black

CUBE 35E (MB) | 3,500W

- Nominal power: 3,500 W
- Voltage V : 220 V 50 Hz / 15.91 Amp
- Flow rate : 3.5 Litre/min
- Water inlet pressure minimum: 0.2 bar
- Size of wire (mm2) : 3 x 2.5 (THW)
- Dimension : 22 X 9 X 29 cm

Color : ● MB Black

ACCESSORIES:



- Rain Shower set
- Shower Matt Black 3 step
- Water Hose S/S x 3 pcs

SPECIAL FUNCTION



Upgrade Safety system with warning indication when grounding or wiring mal abnormal

HALL EFFECT SENSOR*



To detect inlet water system to keep maintaining temperature even in the low water pressure condition

MEX

WATER HEATER

CUBE Series

"Cube Series inspired by Minimal style mixed with Classy vibe easily match with any type of shower room"



Mex Water Heater Model CUBE has been certified International Standard by TÜV SÜD



Adjustable Rain Shower



Switch Button of normal Shower & Rain Shower

CUBE 5E (RAS) | 5,100 W

- Nominal power : 5,100 W
- Voltage V: 220 V 50 Hz / 23.18 Amp
- Flow rate : 3.5 Liter/min
- Water inlet pressure minimum : 0.2 bar
- Size of wire (mm²): 3 x 4.0 (THW)
- Dimension: 22 X 9 X 29 cm

Color : ● Silver

Accessories:



- Rain Shower set
- Chromium shower 5 step
- S/S hose 3 pcs



CUBE 5E (SA), (WH) | 5,100 W

- Nominal power : 5,100 W
- Voltage V: 220 V 50 Hz / 23.18 Amp
- Flow rate : 3.5 Liter/min
- Water inlet pressure minimum : 0.2 bar
- Size of wire (mm²) : 3 x 4.0 THW
- Dimension : 22 X 9 X 29 cm

Color : ● SA Silver Bronze | ○ WH White



CUBE 35E (SA), (WH) | 3,500 W

- Nominal power: 3,500 W
- Voltage V: 220 V 50 Hz / 15.91 Amp
- Flow rate : 3.5 Liter/min
- Water inlet pressure minimum : 0.2 bar
- Size of wire (mm²) : 3 x 2.5 (THW)
- Dimension: 22 X 9 X 29 cm

Color : ● SA Silver Bronze | ○ WH White

Accessories:



- Slide Bar with soap tray
- Chromium shower 5 step
- S/S hose 2 pcs



SPECIAL FUNCTION

Upgrade Safety system with warning indication when grounding or wiring operate abnormally



HALL EFFECT SENSOR*

To detect inlet water system to keep maintaining temperature even in the low water pressure condition

CODE Series

Enjoy Taking shower, refreshing you skin with CODE Water Heater.
Design concept received Demark Design Excellence Award 2013



Mex Water Heater Model CODE has been certified International Standard by TÜV SÜD

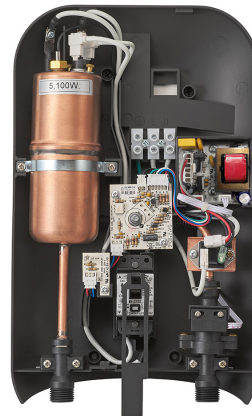

CODE 5E (CB) | 5,100 W

- Nominal power: 5,100 W
- Voltage V: 220 V 50 Hz , 23.18 Amp
- Flow rate : 3.5 Liter/min
- Water inlet pressure minimum : 0.2 bar
- Size of wire (mm2) : 3 x 4.0 (THW)
- The Appliance must be grounded and connect circuit breaker
- Dimension: 21.1 X 7.4 X 35.6 cm

Color : ● CB Black-Copper

CODE 35E (CB) | 3,500 W

- Nominal power : 3,500 W
- Voltage V: 220 V 50 Hz / 15.91 Amp
- Flow rate : 3.5 Liter/min
- Water inlet pressure minimum : 0.2bar
- Size of wire (mm2) : 3 x 2.5. (THW)
- The Appliance must be grounded and connect circuit breaker
- Dimension : 21.1 X 7.4 X 35.6 cm

Color : ● CB Black-Copper



Accessories:

- Slide Bar with soap tray
- Matt Black Shower 3 step
- Black S/S hose 2 pcs



SPECIAL FUNCTION

Upgrade Safety system with warning indication when grounding or wiring operate abnormally



HALL EFFECT SENSOR*

To detect inlet water system to keep maintaining temperature even in the low water pressure condition

MEX

Instant Water Heater

CODE Series

Enjoy Taking shower, refreshing you skin with CODE Water Heater.
Design concept received Demark Design Excellence Award 2013.



Switch valve of Shower and Rain Shower

CODE 5E (RCA) | 5,100 W

- Nominal power: 5,100 W
- Voltage V: 220 V 50 Hz / 23.18 Amp
- Flow rate : 3.5 Liter/min
- Water inlet pressure minimum : 0.2 bar
- Size of wire (mm²) : 3 x 4.0 (THW)
- Dimension : 21.1 X 7.4 X 35.6 cm

Color : ● CA Copper



Mex Water Heater Model CODE has been certified International Standard by TÜV SÜD

Accessories:



- Rain Shower
- Chromium shower 3 step
- S/S hose 3 pcs



CODE 5E (SA), (OA) | 5,100 W

- Nominal power: 5,100 W
- Voltage V: 220 V 50 Hz / 23.18 Amp
- Flow rate : 3.5 Liter/min
- Water inlet pressure minimum : 0.2 bar
- Size of wire (mm²) : 3 x 4.0 (THW)
- Dimension: 21.1 X 7.4 X 35.6 cm

Color : ● SA Silver Bronze ● OA Gold Bronze



CODE 35E (SA), (OA), (CA) | 3,500 W

- Nominal power: 3,500 W
- Voltage V: 220 V 50 Hz / 15.91 Amp
- Flow rate : 3.5 Liter/min
- Water inlet pressure minimum : 0.2 bar
- Size of wire (mm²) : 3 x 2.5. (THW)
- Dimension: 21.1 X 7.4 X 35.6 cmm

Color : ● Silver Bronze ● OA Gold Bronze ● CA Copper



Accessories:

- Slide Bar with soap tray
- Chromium shower 3 step
- S/S hose 2 pcs



SPECIAL FUNCTION

Upgrade Safety system with warning indication when ground-ing or wiring operate abnormal



HALL EFFECT SENSOR*

To detect inlet water system to keep maintaining temperature even in the low water pressure condition.

MEX

COCO Series COCO METALLIC ROSE GOLD

Enjoy Shower with the aesthetics of relaxation in water heater Metallic Series from MEX



Mex Water Heater Model COCO has been certified International Standard by TÜV SÜD

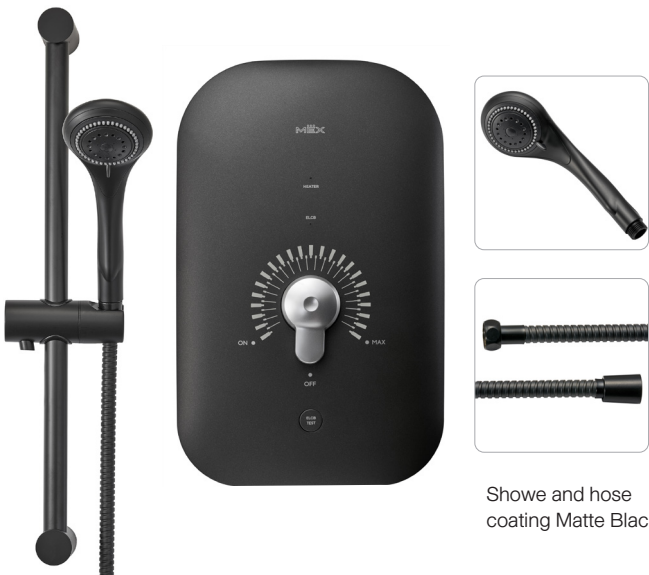

Showers and hose coating Matte Black

COCO 450 (MLB), (MLR) | 4,500 W

- Nominal power : 4,500 W
- Voltage V: 220 V 50 Hz / 20.45 Amp
- Flow rate : 3.5 Liter/min
- Water inlet pressure minimum : 0.2 bar
- Size of wire (mm²) : 3 x 4.0. (THW)
- Dimension : 18.8 x 7.5 x 29.8 cm

Color : ● MLB Black | ● MLR Rose Gold



Showers and hose coating Chocolate Brown

COCO 350 (MLB), (MLR) | 3,500 W

- Nominal power: 3,500 W
- Voltage V: 220 V 50 Hz / 15.91 Amp
- Flow rate : 3.5 Liter/min
- Water inlet pressure minimum : 0.2 bar
- Size of wire (mm²) : 3 x 2.5 (THW)
- Dimension: 18.8 x 7.5 x 29.8 cm

Color : ● MLB Black | ● MLR Rosegold



ACCESSORIES:

- Shower 3 step
- S/S hose 2 pcs
- Slim slide bar



FLOW SWITCH SENSOR

If the water flow is detected flowing very weak by this Sensor, the operation will auto shut off.

Water Heater

Instant Water Heater



Mex Water Heater Model COCO has been certified International Standard by TÜV SÜD



COCO 450 (MRA), (MRB) | 4,500 W

- Nominal power : 4,500 W
- Voltage V: 220 V 50 Hz / 20.45 Amp
- Flow rate : 3.5 Liter/min
- Water inlet pressure minimum : 0.2 bar
- Size of wire (mm²) : 3 x 4.0 (THW)
- Dimension : 18.8 X 7.5 X 29.8 cmm

Color : ● MRA White/Gold | ● MRB White/Pink



COCO 350 (MRA), (MRB) | 3,500 W

- Nominal power: 3,500 W
- Voltage V: 220 V 50 Hz / 15.91 Amp
- Flow rate : 3.5 Liter/min
- Water inlet pressure minimum : 0.2 bar
- Size of wire (mm²) : 3 x 2.5. (THW)
- Dimension : 18.8 X 7.5 X 29.8 cm

Color : ● MRA White/Purple | ● MRB White/Blue



Accessories:

- Slide Bar type Slim
- Chromium shower 3 step
- S/S hose 1 pc



FLOW SWITCH SENSOR

If the water flow is detected flowing very weak by this Sensor, the operation will auto shut off.



COCO 450 (SBA), (SBB) | 4,500 W

- Nominal power : 4,500 W
- Voltage V: 220 V 50 Hz / 20.45 Amp
- Flow rate : 3.5 Liter/min
- Water inlet pressure minimum : 0.2 ba
- Size of wire (mm²) : 3 x 4.0 (THW)
- Dimension : 18.8 X 7.5 X 29.8 cm

Color : ● SBA White/Blue | ● SBB White/Pink



COCO 350 (SBA), (SBB) | 3,500 W

- Nominal power : 3,500 W
- Voltage V: 220 V 50 Hz / 15.91 Amp
- Flow rate : 3.5 Liter/min
- Water inlet pressure minimum : 0.2 bar
- Size of wire (mm²) : 3 x 2.5 (THW)
- Dimension : 18.8 X 7.5 X 29.8 cm

Color : ● SBA White/Blue | ● SBB White/Pink



Accessories:

- White shower 3 step
- PVC hose 1 pc



FLOW SWITCH SENSOR

If the water flow is detected flowing very weak by this Sensor, the operation will auto shut off



13

Water Dispenser

Water Dispenser

COLD-HOT WATER DISPENSER



Normal water
Cold water



Design Slim



Hot water
Normal water
Cold water



cabinet 15 L



Hot water
Normal water
Cold water



Piano
Control
Bottom



Water bottle
put under

ME314-T

- Water Dispenser two-faucet with the pushing forward rinse design (Normal, Cold) Top loading
- Rapid cooling system by compressor with refrigerant R134A -Non-CFC
- Water Tank made from Stainless steel 304
- LED indicator during operation
- Space saving and Minimalist design

Technical Data

- Cooling watts : 120W
- Chilled water temperature ≤ 10 .C
- Chilled water capacity 3 Liter
- Weight : 13.9 kg
- Dimension : 24.7x 30.3 x 108.6 cm
- Warranty Product 1 Year Compressor 5 Year

ME317-T

- Water Dispenser three-faucet design (Hot, Normal, Cold) Top loading
- Double safety device to prevent over heat
- Child safety lock for hot water faucet
- High power stainless steel hot water tank • 15L spacious cabinet

Technical Data

- Heating watts : 420W
- Cooling watts : 120W
- Heated water temperature ≥ 85 .C
- Chilled water temperature ≤ 10 .C
- Heated water capacity 1.02 Liter
- Chilled water capacity 3 Liter
- Weight : 13.6 kg
- Dimension : 31x 36 x 100.5 cm
- Warranty Product 1 Year Compressor 5 Year

ME316-B

- Water Dispenser (Hot, Normal, Cold) Bottom loading design Water Bottom place under
- Double safety device fo preventing over heat
- Child safety lock for hot water faucet
- High power stainless steel hot water tank
- Space saving and Minimalist design
- Adjustable drip tray
- Running out of water indicator

Technical Data

- Heating watts : 420W
- Cooling watts : 100W
- Heated water temperature ≥ 85 .C
- Chilled water temperature ≤ 10 .C
- Hot water capacity 1.16 Lite
- Chilled water capacity 3.6 Liter
- Weight : 14.8 kg
- Dimension : 31x 36 x 104 cm
- Warranty Product 1 Year Compressor 5 Year

(*NOT INCLUDE PLASTIC TANK.)



14

Household Water Filter

Water quality defines Quality of life

Filter Media: สารกรองน้ำคุณภาพ



Sand Filter

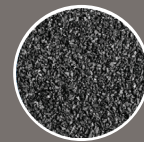

Carbon Filter



Birm Filter

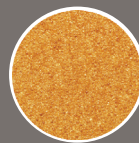

Resin Bead



Salt Tablet

BIG BLUE system

“Household Water Filter model Big Blue from PENTAIR is designed to filtrate high flow application from water supply, and there are various filter types for big particle, small particle, Chlorine and Chemical, Calcium Carbonate and Manganese. ”

BIG BLUE Size 20 inches : For Small to Medium size households which applied to City Water Supply

BB20-R30

30 Micron



- To filtrate floating particle 30 micron
- The Pleated Polyester Fabric Filter can expand filtering area, and be reusable.
- High-quality polyester filter membranes. Resistant to chemicals and bacteria
- Water flow rate: 76 liters per minute
- Max Pressure: 6.2 Bar



BB20-DGD5005

5 Micron



- To filtrate floating particle 5 micron
- High quality POLYPROPYLENE filter 2 layers (outer layer 50 micron and inner layer 5 micron) to prolong service life 233%
- Water flow rate: 76 liters per minute
- Max Pressure: 6.2 Ba



BB20-RFC

Carbon



- To filtrate Chlorine and Chemical
- Granular Activate Carbon Filter to reduce 25 microns of odor, color and taste from the water.
- Water flow rate: 15.2 liters per minute
- Max filtrating rate: 378,541 Liters
- Max Pressure: 6.2 Ba



BB20-RFFE20

Birm



- To filtrate Calcium Carbonate and Manganese
- High Quality Brim Filter to filtrate 3 ppm manganese
- To reduce rust stain on sink, bathtub, toilet and cloth.
- Water flow rate: 31.67 liters per minute
- Max filtrating rate: 98,400 Liters
- Max Pressure: 6.2 Ba

BIG BLUE Size 10 inches: For Condo or Small size households which applied to City Water Supply

BB10-R30

30 Micron



- To filter floating particle 30 micron
- The Pleated Polyester Fabric Filter can expand filtering area, and be reusable.
- High-quality polyester filter membranes. Resistant to chemicals and bacteria
- Max water flow rate: 36.7 liters per minute / Max filtrating rate: 113,400 Liters
- Max Pressure: 6.2 Bar

BB10-DGD2501

1 Micron



- To filtrate floating particle 1 micron
- High quality POLYPROPYLENE filter 2 layers (outer layer 25 micron and inner layer 1 micron) to prolong service life 233%
- Max water flow rate: 36.7 liters per minute
- Max Pressure: 6.2 Bar



BB10-CFB PLUS

Carbon



- To filtrate Chlorine and Chemical
- Carbon Fiber Block Filter to reduce 5-10 microns of odor, color and taste from the water.
- Water flow rate: 7.6 liters per minute
- Max Pressure: 6.2 Bar



Sizing 10 x 54 : Big House

Hydra Smart : Smart Carbon Filter For Homes

Carbon

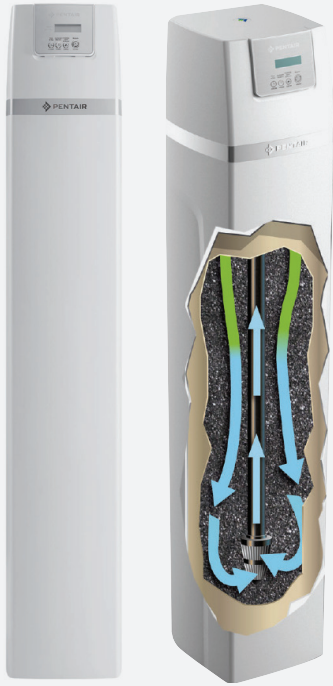

PCFE54P12 : Activated Carbon

- Household Water Filter Auto System
- Hydra Smart Program with Touch screen and regenerate system
- To filtrate chlorine, chemical filters, odors, colors, unwanted flavors in water
- Filtration with KDF which it helps hydrogen sulfide filter, heavy metals filter and inhibit the growth of bacteria.
- Suitable for : Large size House 3-4 restrooms.
- Warranty 1 year

TECHNICAL DATA

- Rate Operating Flow Rate: 2.7 m3/h
- Tank Material: High Quality Structural FRP
- Tank Size: 10 inc x 54 inc
- Control Valve: PENTAIR Model 363TC Auto control
- Power Supply: 220V/50Hz
- Filter Type: Activate Carbon



save cost



convenience



Reduce white stain



Prolong the service life of the appliances



Environment friendly

ขนาดถึง 10 x 54 : Big House

Hydra Smart : 8- Stages Smart Water Softening

Resin



PWCE54P12 : Water Softener

- Household Water Filter Auto System
- The Hydra Smart program comes with a touch screen. and has an 8-step regenerate system, which compared to the general standard has 5 steps.
- To reduces scale when boiling water. Reduce the use of detergent when washing clothes. Soften clothes by using less fabric softener.
- To reduce stains in the bathroom and sanitary ware. Reduce white stains on dishes Reduce the use of soap when taking a shower and washing your hair.

Make your skin soft.

- Suitable for: Large size House 3-4 restrooms
- Warranty 1 year

TECHNICAL DATA

- Rate Operating Flow Rate: 3.0 m3/h
- Tank Material: High Quality Structural FRP
- Tank Size: 10 inc x 54 inc with salt tank 80 liter for resin cleaning
- Control Valve: PENTAIR Model 368 Auto control
- Power Supply: 220V/50Hz
- Filter Type: Resin Bead



save cost



convenience



Reduce white stain



Prolong the service life of the appliances



Environment friendly

Sizing 8 x 44 : Small House



0844-363TC-AC : Activated Carbon

- Household Water Filter Auto System
- To filtrate Chlorine and Chemical, to remove odor, color and unwanted flavors in water
- Suitable for: Small size House 1-2 restrooms
- Warranty 1 year

TECHNICAL DATA

- Rate Operating Flow Rate: 0.4-0.6 m3/h
- Tank Material: High Quality Structural FRP
- Tank Size: Dia 8 inc x 44 inc H
- Control Valve: PENTAIR Model 363TC Auto control
- Power Supply: 220V/50Hz
- Filter Type: Activate Carbon

Carbon

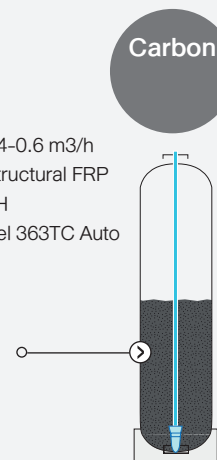

Sizing 8 x 44 : Small House



0844-366TC-SOFT : Water Softener

- Auto Water softener
- To soften hard water, reduce calcium carbonate
- To reduce descale in boiled water , using small amount of detergent for laundry and to reduce white strain on sanitaryware and kitchen utensils. When taking shower, it softens your skin.
- Suitable for: Small size House 1-2 restrooms
- Warranty 1 year

TECHNICAL DATA

- Rate Operating Flow Rate: 0.6-0.9 m3/h
- Tank Material: High Quality Structural FRP
- Tank Size: Dia 8 inc x 44 inc H
- With Salt Tank for Clean Resin 25 L
- Control Valve: PENTAIR Model 367TC Auto control
- Power Supply: 220V/50Hz
- Filter Type: Resin Bead

Resin



Sizing 12 x 52 : Big House



Control Valve
BR-XSM Model
Pentair Automatic
System

PR-1252BR-XSM : Water Softener

- Auto Water softener
- To soften hard water, reduce calcium carbonate
- To reduce descale in boiled water , using small amount of detergent for laundry and to reduce white strain on sanitaryware and kitchen utensils. When taking shower, it softens your skin.
- Suitable for: Large size House 3-4 restrooms
- Warranty 1 year

TECHNICAL DATA

- Rate Operating Flow Rate: 1.4-1.78 m3/h
- Tank Material: High Quality Structural FRP
- Tank Size: Dia 12 inc x 52 inc H
- With Salt Tank for Clean Resin 100 L
- Control Valve: PENTAIR Model BR-XSM Auto control
- Power Supply: 240V/50H
- Filter Type: Resin Bead

MEX

Resin



Household Water Filter

Automatic : Household Water Filter : Auto System

Sizing 12 x 52 : Big House



Control Valve
BR-AFT Model
Pentair Automatic System

*Warranty 1 year

PS-1252BR-AFT : Sand Filter

Sand

- To filtrate floating particle 30 micron
- To filtrate big particle like pebble, stone and mud
- Suitable for: Large size House 3-4 restrooms and water problem area

TECHNICAL DATA

- Rate Operating Flow Rate: 1.4-1.67 m3/h
- Tank Material: High Quality Structural FRP
- Tank Size: Dia 12 inc x 52 inc H
- Control Valve: PENTAIR Model BR-AFT Auto control
- Power Supply: 220V/50Hz
- Filter Type: Sand Filter

Sizing 10 x 54 : Medium House



Control Valve
AF4-LCD Model
MEX Automatic System

*Warranty 1 year

APS-1054-ELCD : Sand Filter

Sand

- To filtrate floating particle 30 micron
- To filtrate big particle like pebble, stone and mud
- Suitable for: Medium size House 2-3 restrooms

TECHNICAL DATA

- Rate Operating Flow Rate: 1-1.2 m3/h
- Tank Material: High Quality Structural FRP
- Tank Size: Dia 10 inc x 54 inc H
- Control Valve: MEX Model AF4-LCD Auto control
- Power Supply: AC100-240V/50-60Hz
- Filter Type: Sand Filter

Sizing 10 x 54 : Medium House



Control Valve
ASD4-LCD Model
MEX Automatic System

*Warranty 1 year

APR-1054-ELCD : Water Softener

Resin

- To soften hard water, reduce calcium carbonate
- To reduce descale in boiled water , using small amount of detergent for laundry and reduce white strain on sanitaryware and kitchen utensils. When taking shower, it softens your skin.
- Suitable for: Medium size House 2-3 restrooms

TECHNICAL DATA

- Rate Operating Flow Rate: 1.2 m3/h
- Tank Material: High Quality Structural FRP
- Tank Size: Dia 10 inc x 54 inc H
- With Salt Tank for Clean Resin 100 L
- Control Valve: MEX Model ASD4-LCD Auto control
- Power Supply: AC100-240V/50-60Hz
- Filter Type: Resin Bead

FREE!
Tablet
Salt
25KG



PC-1252BR-AFT : Activated Carbon

Carbon

- To filtrate Chlorine and Chemical
- To filtrate odor, color and unwanted flavors in the water.
- Suitable for: Large size House 3-4 restrooms and water problem area

TECHNICAL DATA

- Rate Operating Flow Rate: 1.4-1.67 m3/h
- Tank Material: High Quality Structural FRP
- Tank Size: Dia 12 inc x 52 inc H
- Control Valve: PENTAIR Model BR-AFT Auto control
- Power Supply: 220V/50Hz
- Filter Type: Activated Carbon

PB-1252BR-AFT : Brim Filter

Brim

- To filtrate Calcium carbonate and manganese
- To reduce rust stain on sink, bathtub, sanitary and cloths.
- Suitable for: Large size House 3-4 restrooms and water problem area

TECHNICAL DATA

- Rate Operating Flow Rate: 1.4-1.67 m3/h
- Tank Material: High Quality Structural FRP
- Tank Size: Dia 12 inc x 52 inc H
- Control Valve: PENTAIR Model BR-AFT Auto control
- Power Supply: 220V/50Hz
- Filter Type: Brim Filter

APC-1054-ELCD : Activated Carbon

Carbon

- To filtrate Chlorine and Chemical
- To filtrate odor, color and unwanted flavors in the water.
- Suitable for: Medium size House 2-3 restrooms and water problem area

TECHNICAL DATA

- Rate Operating Flow Rate: 1-1.2 m3/h
- Tank Material: High Quality Structural FRP
- Tank Size: Dia 10 inc x 54 inc H
- Control Valve: MEX Model AF4-LCD Auto control
- Power Supply: AC100-240V/50-60Hz
- Filter Type: Activated Carbon

APB-1054-ELCD : Brim Filter

Brim

- To filtrate Calcium carbonate and manganese
- To reduce rust stain on sink, bathtub, sanitary and cloths.
- Suitable for: Medium size House 2-3 and water problem area

TECHNICAL DATA

- Rate Operating Flow Rate: 1-1.2 m3/h
- Tank Material: High Quality Structural FRP
- Tank Size: Dia 10 inc x 54 inc H
- Control Valve: MEX Model AF4-LCD Auto control
- Power Supply: AC100-240V/50-60Hz
- Filter Type: Brim Filter

Sizing 10 x 44 : Medium House



Control Valve
ASD4-LCD Model
MEX Automatic System

APR-1044-ELCD : Water Softener

Resin

- To soften hard water, reduce calcium carbonate
- To reduce descale in boiled water , using small amount of detergent for laundry abd reduce white strain on sanitaryware and kitchen utensils. When taking shower, it softens your skin.
- Suitable for: Small size House 2 restrooms

TECHNICAL DATA

- Rate Operating Flow Rate: 1.2 m3/h
- Tank Material: High Quality Structural FRP
- Tank Size: Dia 10 inc x 44 inc H
- With Salt Tank for Clean Resin 100 L
- Control Valve: MEX Model ASD4-LCD Auto control
- Power Supply: AC100-240V/50-60Hz
- Filter Type: Resin Bead



FREE!
Tablet
Salt
25KG

*Warranty 1 year

Household Water Filter

Household Water Filter : Manual System

Sizing 10 x 54 : Medium House



Control valve :
FV-10005 Model
(Manual System) by Pentair

*Warranty 1 year

MPS-1054-FV : Sand Filter

- To filtrate floating particle 30 micron
- To filtrate big particle like pebble, stone and mud
- Suitable for: Medium size House 2-3 restrooms

TECHNICAL DATA

- Rate Operating Flow Rate: 1-2 m3/h
- Tank Material: High Quality Structural FRP
- Tank Size: Dia 10 inc x 54 inc H
- Control Valve: PENTAIR FV-10005 Manual control
- Filter Type: Sand Filter

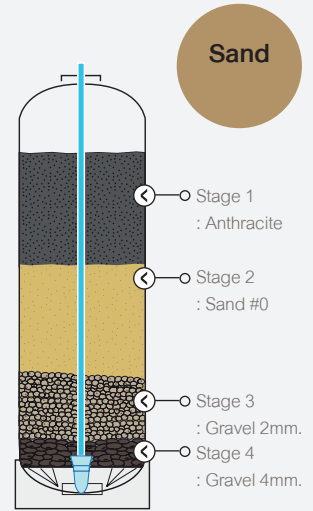

Sizing 10 x 44 : Small House



Control valve :
BNT111 Model
(Manual System) by MEX

*Warranty 1 year

MPS-1044-P : Sand Filter

- To filtrate floating particle 30 micron
- To filtrate big particle like pebble, stone and mud
- Suitable for: Small size House 2 restrooms

TECHNICAL DATA

- Rate Operating Flow Rate: 1-1.2 m3/h
- Tank Material: High Quality Structural FRP
- Tank Size: Dia 10 inc x 44 inc H
- Control Valve: MEX model BNT111 Manual control
- Filter Type: Sand Filter



Salt Tablets : Water Softener Salt Tablets



- Water Softener Salt Tablets are intended to effectively clean, regenerate and prolong the life of resin media filter. It consists of Calcium (Ca) and Magnesium (Mg)
- Salt tablets are made from 99.8% pure salt.
- Certify safety which meets European Standards EN973A.
- Clean and contamination-free salt tablets.
- Effectively regenerates and prolongs the life of resin media filter.
- Capacity 10 kgs

Specification :

Parameters	Sales guarantees
Sodium chloride (NaCl)	≥ 99.8%
Moisture Content	≤ 0.6%
Water-Insoluble Matter	≤ 0.05%
Ca2 + Mg2	≤ 20 ppm
Pb	≤ 1.0 ppm
As	≤ 0.3 ppm
Cd	≤ 0.5 ppm
Hg	≤ 0.1 ppm
Cr	≤ 0.5 ppm
Ni	≤ 0.5 ppm
Sb	≤ 2.0 ppm
Se	≤ 2.0 ppm
Br	≤ 150 ppm



Control valve :
FV-10005 Model
Pentair Manual System

*Warranty 1 year

MPC-1054-FV : Activated Carbon

- To filtrate Chlorine and Chemical
- To filtrate odor, color and unwanted flavors in the water.
- Suitable for: Medium size House 2-3 restrooms

TECHNICAL DATA

- Rate Operating Flow Rate: 1-2 m3/h
- Tank Material: High Quality Structural FRP
- Tank Size: Dia 10 inc x 54 inc H
- Control Valve: PENTAIR FV-10005 Manual control
- Filter Type: Activated Carbon

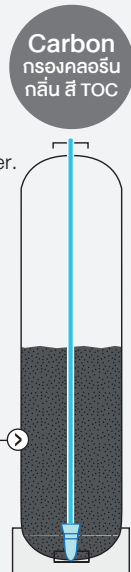

MPC-1044-P : Activated Carbon



- To filtrate Chlorine and Chemical
- To filtrate odor, color and unwanted flavors in the water.
- Suitable for: Small size House 2 restrooms

TECHNICAL DATA

- Rate Operating Flow Rate: 1-1.2 m3/h
- Tank Material: High Quality Structural FRP
- Tank Size: Dia 10 inc x 44 inc H
- Control Valve: MEX model BNT111 Manual control
- Filter Type: Activated Carbon

MPCS-1044-P : Sand + Activated Carbon



- To filtrate floating particle 30 micron
- To filtrate big particle like pebble, stone and mud
- To filtrate Chlorine and Chemical
- To filtrate odor, color and unwanted flavors in the water.
- Suitable for: Small size House 2 restrooms

TECHNICAL DATA

- Rate Operating Flow Rate: 1-1.2 m3/h
- Tank Material: High Quality Structural FRP
- Tank Size: Dia 10 inc x 44 inc H
- Control Valve: MEX model BNT111 Manual control
- Filter Type: Sand Filter+ Activated Carbon



TRIPS & TRICKS :

- Please carefully read and check Instruction manual before use.
- Please check water quality from water supply to select water filter suitable for water problem area.
- Installation area should be on flat floor, near the water drainer. Do not install where system will be exposed to direct sunlight.
- Water Filter should fix on the floor, its height is not over 20 feet [6.1 meters] from the drainer.
- Drainer hose level should be lifted up high and its hose tip must fix lower than control valve level.
- Knot the tip of drainer hose to stop its moving.
- Recommend to change new water filter every 10 years or its limited service life depending on water condition area, usage and maintenance.
- Should take note Date of Installation and filter cartridge replacement date for remind the next replacement.
- Water Filter warranty 1 year [12 months] except consumable part.



15

Drinking Water Purifier

Enjoy next level of taste of water

Professional Water Purifier from Korea, designed with innovative Nanofiltration to enhance performance of particle filtration to 0.01-0.001 micron and filtrate virus and bacteria, manganese chemical in the water.

Drinking Water Purifier



PENTAIR ENERAGON

Water Purifier PENTAIR ENERAGON S-UU RO Model S-2000 (Dual Faucet)

- RO membrane performance: 8L/hour
- System Flowrate : 1.5 L/min
- Inlet Water Pressure : 15-55 PSI [1-4 Bar]
- Operating Pressure : 60-110 PSI [4-7.5 Bar]
- Operating Environment
- Ambient Temperature 4-40 C
- Relative Humidity ≤90%
- Power Supply : 110-250V, 50/60Hz
- Power : 25W
- LED Display



SMART DIGITAL DISPLAY

Smart Visual Display showing quality of purified water

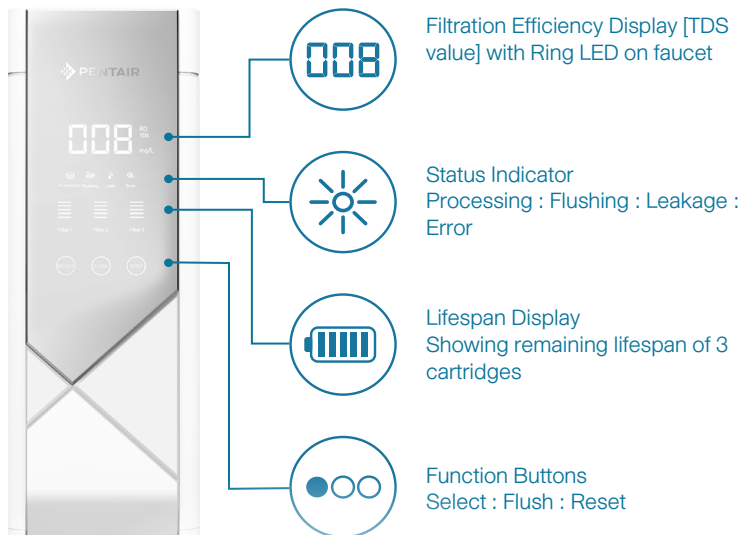



S2000-S1 CART

Filter PP + Carbon Block to filtrate Chemical, odor, color and unwanted particle in the water



S2000-S2 CART

Filter RO remove TDS and Calcium Carbonate



S2000-S3 CART

Filter Post Carbon Ador and Water taste



Filter RO Premium Quality, Economize and Environment Friendly

Filter RO Capacity 50 GPD , filtrate particle smaller than virus

Filtration particle size 0.0001mcron

Reduce TDS level up to 90%

Design DUAL-FAUCET Dual Faucet design and dual filtration mode for drinking water and household water

Drinking Water Purifier

Drinking Water Purifier



GRO-50 SYSTEM

RO
0.0001 Microm



- Water Purifier GREEN RO System enhance filtration performance with purifier water vs drainer water 1:1
- To filtrate total contaminants with a size of 0.0001 microns.
- 5 stages filtration system.
- Stage 1: PP sediment filter, To filtrate floating particle with a size of 5 microns.
- Stage 2 : GAC-10 Filter, to filtrate unwanted odor, color of the water
- Stage 3 : EPM-10 offers excellent absorption, removes color, filtrate organic matters and improves the quality of the water 10 micron.
- Stage 4 : GRO-50EN filtrate TDS and

- removes small suspensions, heavy metals and organic matters in the water.
- Stage 5 : Inline Post Carbon [GS-10RO] improves the taste of the water.
- Flowrate : 8 L/ hour
- Pressure Tank Capacity: 10 L.

NSF
COMPONENT

- Filter GRO-50EN filter is certified with NSF/ANSI Std.58 (COMPONENT)
- Filter GAC-10, EPM-10, INLINE POST CARBON filter is certified with NSF/ANSI NO.42 (COMPONENT)

 PP sediment C255430-49L filtrate contaminants with a size of 5 microns.	 Filter GAC-10 to filtrate unwanted odor, color of water	 Filter EPM-10 filtrate organic matters and improves the quality of the water.	 Filter GRO-50EN filtrate TDS and removes small suspensions, heavy metals	 Filter Inline Post Carbon (GS-10RO) improves the taste of the water
---	--	--	--	--

MN 021W

Nano
0.001 Micron



- Countertop water purifier and dispenser with the power cord
- To filtrate contaminants with a size 0.01 -0.001 micron
- 5 stages filtration system.
- Stage 1: PP sediment filter, to filtrate floating particle 5 micron.
- Stage 2-4 : Natural Plus [Carbon Block] Filter to filtrate odor, color and improves the taste of the water and increase minerals in the water with mineral ball.
- Stage 5 : Nano Positive Filter to filtrate, heavy

- metals and organic matters in the water with a size 0.001 micron.
- Flowrate: 1.1 L/ min
- Water pressure: 1.5-6.9 Bar
- Rated Capacity: 3,600 L
- Power Supply : 220-240V, 50Hz
- Power : 14.5W
- Can be fixed to other faucet



 Filter Sediment Filter Replacement Cycle: 4 months	 Filter Natural Plus Filter Replacement Cycle: 8 months	 Filter Nano Positive Plus Filter Replacement Cycle: 12 months
---	--	--



Drinking Water Purifier

Drinking Water Purifier



PRO-4

UF
0.15 Micron



- High performance water purifier Ultra-filtration [UF] system wall-mounted installation.
- Hollow Fiber Membrane reduces sediment, bacteria, virus and cysts, and Carbon block to absorb chemical agent and toxin.
- the filter resolution is 0.15 microns
- Reduces bacteria 99.9999% and virus 99.9999%
- to filtrate odor, color and improves the taste of the water
- to filtrate Chlorine, Chemical and lead
- Aluminium Filter cartridge

- Flowrate: 3.8 L/ min
- Filtration Capacity: 3,600 gallons [13,600 L]
- Extra Pre Filter tank with premium filter CTS-100M comes with free faucet

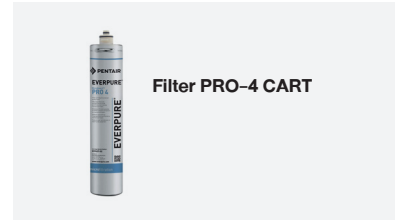

PBS-400

MF
0.5 Micron
INDEPENDENTLY CERTIFIED NSF



- High performance water purifier designed to fit with any kitchen faucet
- the filter resolution is 0.5 microns [NSF certified]
- To filtrate bacteria and cysts. [NSF certified]
- To filtrate odor, color and improve taste of the water.
- To filtrate chemical agent, chlorine and lead.

- Reduce the scale inhibitor by Polyphosphate.
- Flowrate: 8.3 L/ min
- Filtration Capacity: 3,000 gallons [11,355 L]
- Extra Pre Filter tank and free faucet



H-104

S-UU MF
0.5 ไมครอน
INDEPENDENTLY CERTIFIED NSF



- High performance water purifier wall-mounted installation
- Innovative Micropure Filter enhances filtration performance and Super Fine Carbon to absorb chemical agent and toxin.
- the filter resolution is 0.5 microns [NSF certified]
- To filtrate bacteria and cysts. [NSF certified]
- To filtrate odor, color and improve taste of the water
- Aluminum Filter cartridge

- To filtrate chemical agent, chlorine and lead.
- Reduce the scale inhibitor by Polyphosphate.
- Flowrate: 1.9 L/ min
- Filtration Capacity: 1,000 gallons [3,780L]
- Extra Pre Filter tank and free faucet.



Drinking Water Purifier

Drinking Water Purifier



SPA-400



MF

0.5 Micron



- Water Purifier is designed to connect to your existing lavatory faucet for washing face.
- To reduce chemical impurities, making it the perfect water source for skin softening.
- To filtrate floating particle 0.5 micron [certified]
- To filtrate Bacteria such as cyst [certified]
- To filtrate color, odor and improve taste of the water.
- To filtrate Chemical, chorine and lead.

- Aluminium Filter cartridge
- Flowrate: 8.3 L/ min [2.2 gallons /min]
- Filtration Capacity: 3,000 gallons [11,355 L]

Check Standard NSF
NSF/ANSI No.42
NSF/ANSI No.53
SCAN HERE



Filter SPA-400 CART

F-3000-B2B



MF

0.5 Micron



- Water Purifier wall-mounted installation with 3-stages filtration systems
- Stage 1 : PP sediment filtrate particle with a size 5 micron
- Stage 2 : Carbon Block filtrate floating particle 1 micro
- Stage 3 : Carbon Block filtrate small particle 0.5 micron
- To filtrate Bacteria such as cysts.[Certified]
- To reduce color, odor and improve taste of water.
- To filtrate the VOCs and organic chemicals such as chlorine, lead and pesticides.
- Flowrate : 2.27 L/ min
- Filtration Capacity : 675 gallon [2,555 L]
- Free Faucet

Check Standard NSF
NSF/ANSI No.42
NSF/ANSI No.53
SCAN HERE



Filter F1S5-RC REPLACEMENT CARTRIDGE



Filter F2B2-RC2 REPLACEMENT CARTRIDGE, TWIN SET

F-2100



MF

0.5 micron

- Water Purifier wall-mounted installation with 2-stages filtration systems
- Stage 1 : PP sediment filtrate some particle with a size 5 micron
- Stage 2 : Carbon Fiber Block to filtrate small particle 0.5 micron
- To filtrate Bacteria such as cysts.
- To reduce color, odor and improve taste of water.
- To filtrate chemicals such as chlorine.
- Flowrate : 1.5 L/ min
- Filtration Capacity : 750 gallon [2,839 L]
- Free Faucet



Filter PP REPLACEMENT CARTRIDGE



Filter FIBERDYNE REPLACEMENT CARTRIDGE, TWIN SET

Drinking Water Purifier

Drinking Water Purifier



CTD-100M

MF **0.5 Micron**



- Water Purifier Countertop with 2-stages filtration system
- Stage 1 : PP sediment filtrate some particle with a size 5 micron
- Stage 2 : Carbon Fiber Block to filtrate small particle 0.5 micron
- Add Silver Ion Technology to resist bacteria growth.
- To filtrate Bacteria such as cysts.
- To reduce color, odor and improve taste of water.
- To filtrate chemicals such as chlorine.
- Flowrate : 6.4 L/ min
- Filtration Capacity: 22,680 gallon or not over 1 year



PP Filter C255430-49L

Filter CTS-100M CARTRIDGE



NSF
COMPONENT

Everpure Designer Faucet Chrome

- Drinking Faucet premium quality
- Certified by NSF/ANSI NO.61
- Flowrate 1.9 L/ min
- Ceramic dish cartridge and aerator
- Dimension: 5x5x28 cm
- Weight: 0.5 kg.



NFS INTERNATIONAL

The NSF mark is your assurance that a product has been tested by a trusted independent certification organization as follow

- 1) Material Safety
- 2) Structural Integrity
- 3) Specific Health-related contaminated reduction claims {Claim vary by production}



NSF/ANSI COMPONENT

To certify products components, or material that come into contact with drinking water purifier, but it is not included the whole body of water purifier.

NSF/ANSI 42 :

Drinking water treatment unit-Aesthetic Effects claims Chlorine, taste and odor, chloramine, particulate, iron, manganese, zine and total dissolves solids [TDS]
 Certified model
 NSF/ANSI No.42
 - H-104
 - H-300-NXT
 - PBS-400
 - SPA-400
 - F-3000-B2B

NSF/ANSI No.53 :

Drinking water treatment unit-Health Effects claims 50 contaminant reduction claims, such as lead, cryptosporidium, VOCs and Chromium
 Certified model
 NSF/ANSI No.53
 - H-104
 - H-300-NXT
 - PBS-400
 - SPA-400
 - F-3000-B2B

NSF/ANSI No.58 :

Drinking water purifier Reverse Osmosis® the standard included TDS reduction performance , VOC and Cyst
 Certified model
 NSF/ANSI No.58
 - GRO-50 System (Component)

NSF/ANSI No. 61 :

Drinking Water System Components
 - Health Effects
 Certified model
 NSF/ANSI No. 61
 - BB20-DGD5005
 - BB20-RFC
 - BB10-DGD2501
 - BB10-CFB PLUS

NSF/ANSI 401 :

Emerging compounds/ incidental contaminants. The standard address ability to remove contaminant reduction such as prescription drugs and OTC
 Certified model
 NSF/ANSI No. 401
 - H-300 NXT

ARI Air Fryer

Juicy & Crispy Perfect Food

"Yummy" with Rapid Air makes food crispy and delicious. and thoroughly cooked with Oil free for healthy food



CONTACT
CALL CENTER :
Tel : (+66) 02-493-6565
Email : contact@penk.co.th

SERVICE CENTER
Tel : (+66) 02-493-6565
Fax : 0-2464-1600
Email : servicecenter@penk.co.th



CATALOG 2023
f mexappliance
m mexappliance
@mexappliance
www.mexappliance.com